

Prof. Madhur Behl

madhur.behl@virginia.edu

Assistant Professor

Dept. of Computer Science,

Dept of Engineering Systems and Environment

UVA Link-Lab

F1/10 Autonomous Racing Founder and Race Director

Director of Cavalier Autonomous Racing

Research: Artificial Intelligence, Robotics, Autonomous Systems, and Control Systems

Applications: Cyber-Physical Systems, Smart Cities, and Autonomous Vehicles

PhD, MS: University of Pennsylvania

Co-Founder Flexergy.ai [NSF SBIR]



Physicist at 
Cyber-Physicist by profession

Smart Cities

Smart and
Connected Health

Autonomous
Systems

CS

ECE

SIE

Civil

ME

LINK
LAB

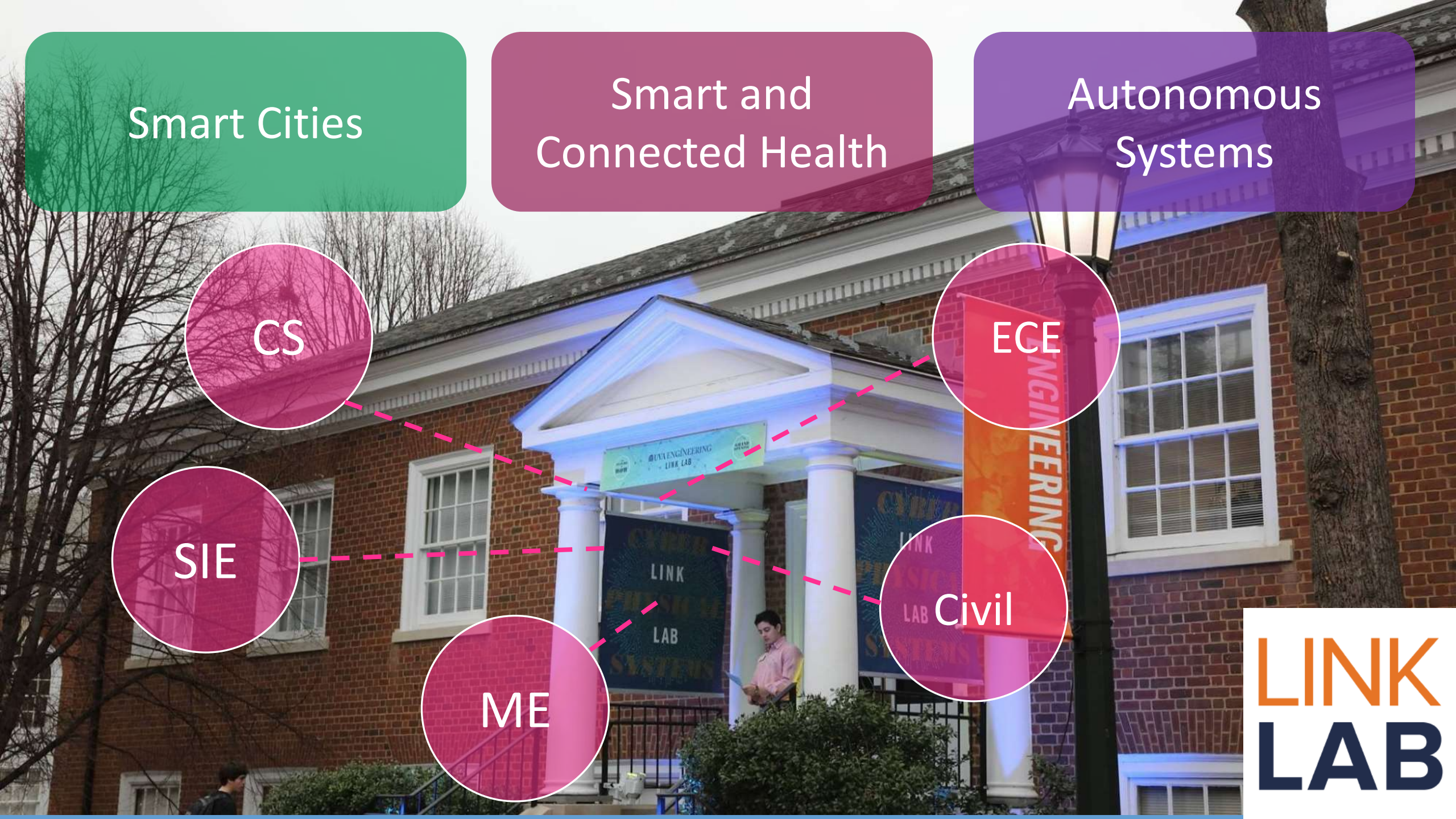

What do I do..

Modeling, simulation, control, optimization, and implementation of Cyber-Physical System



Cyber-Physical Energy Systems



Internet of things

Data Predictive Control:

Interfacing machine learning suitable for predictive control.

DeepExplanations:

Answering open-ended queries using procedural generation and interpretable models.

DeepRacing AI:

Algorithms for operating autonomous cars at the limits of their control

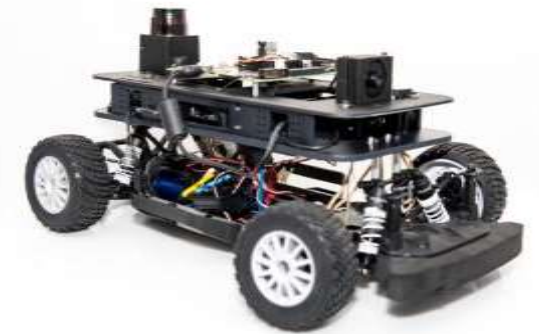

Safety of Autonomous Vehicles



Critical Infrastructures & Smart Cities

Artificial Intelligence for Autonomous Racing

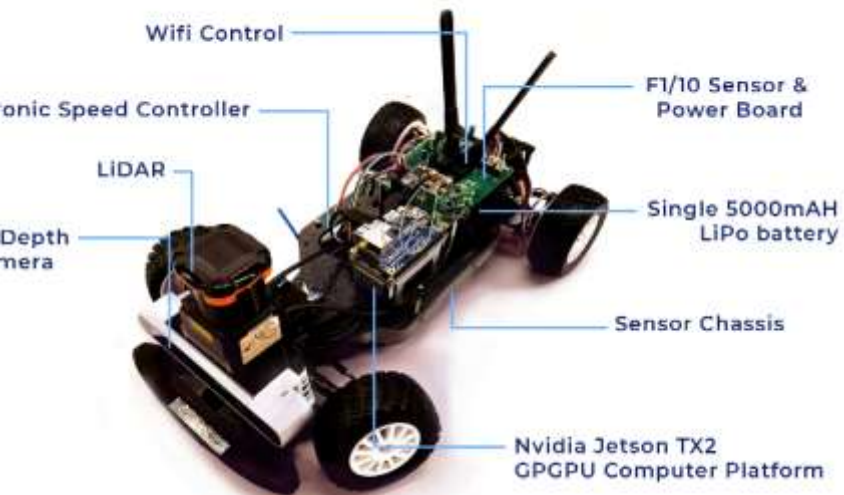

The Internet of Wasted Things



Autonomous Electric Vehicle Charging Robot

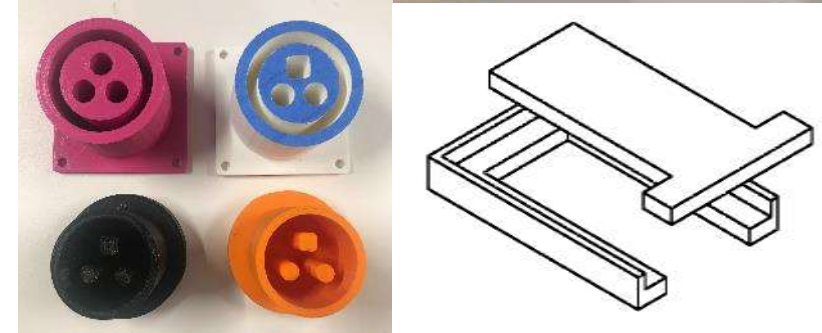
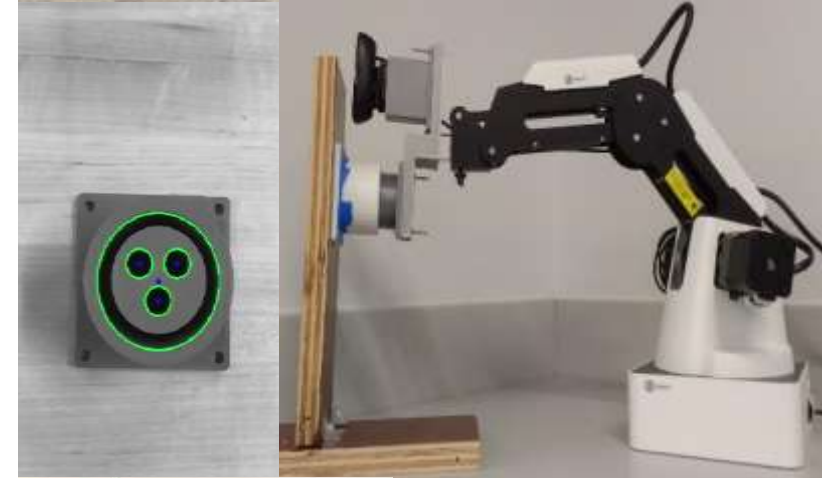

This lecture

- Course logistics (5-7 mins)
- Course introduction (the interesting stuff !)

Course Logistics

- **Timings:** Video Lectures released on Tue & Thu,
- **Location:** Online Asynchronous (on Collab) – with live office hours

- **Course website:** https://linklab-uva.github.io/modeling_cps/
- All lectures notes/slides/assignments/will be posted on this website.

- **Piazza:** piazza.com/virginia/fall2020/cs6501003sys6581005/home

- **Prerequisites (must have):**
 - Familiarity with Matlab / Simulink.
 - Mathematical maturity (differential equations, matrix operations, some calculus, probability distributions)
- **Prerequisites (good to have):**
 - Machine learning
 - Temporal logic
 - Model predictive control

Teaching Assistants

Aron Harder



ah2ph@virginia.edu

Computer Science, PhD

Office Hours: TBA

Grading

- No midterm, No final exam.
- The course has three modules (more on this later). Each module is equally weighted.
 - Energy CPS, Medical CPS, and Automotive CPS
- ~3-4 assignments in each module, comprising of:
 - Problem sets
 - Coding/implementation assignments
- 2 late homework submissions permitted – No questions asked.
 - Should not be late by more than 1 day. 25% grade lost for each additional late day.
- Abide by the UVA honor system. Absolutely no code/solution sharing!

Office Hours

- **Timings:** Monday 2-3pm, or by appointment.
- **Location:** On Zoom [Link and pwd will be released on piazza]
- Available by appointment outside of the listed hours:
 - To discuss course assignments or lectures.
 - Research opportunities.
- Live office hours will also be held by the TA.

Your responsibilities.

- Watch the videos for the lectures
- Check Piazza and the Course website for announcements, and assignments.
- Ask questions on piazza and during the weekly office hours!
 - Ask, disagree, debate..

what is this course about ?

Principles of Modeling for **Cyber-Physical Systems**

Lets break it down..

1. **What are Cyber-Physical Systems ?**
2. What do you really mean by modeling ?
3. What principles am I going to learn about ?

Cyber-Physical Systems

Deeply integrating

computation, communication, and control

into **physical systems**

❓ **Physical** = some tangible, physical device or system + environment

❓ **Cyber** = computational + communication

Application domains: Transportation



Faster, safer, more energy-efficient air travel



Improved use of airspace



Autonomous unmanned drones

How the MCAS (Maneuvering Characteristics Augmentation System) works on the 737 MAX

1. The angle-of-attack sensor aligns itself with oncoming airflow.

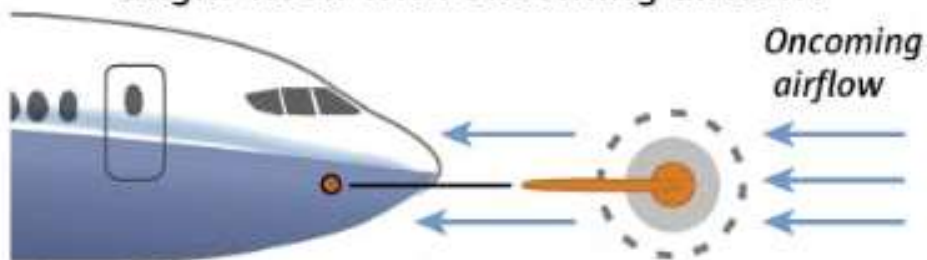

Level flight

The angle of attack is the angle between the wing and the airflow.

2. Data from the sensor is sent to the flight computer.

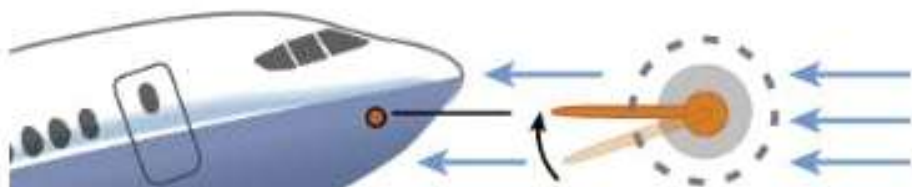

Nose-up flight

If the angle rises too high, suggesting an approaching stall ...

... the MCAS activates.

3. MCAS automatically swivels the horizontal tail to lift the plane's tail while moving the nose down.



Horizontal tail

In the Lion Air crash, the angle-of-attack sensor fed false information to the flight computer.

Sources: Boeing, FAA, Indonesia National Transportation Safety Committee, Leeham.net, and The Air Current

Reporting by DOMINIC GATES,
Graphic by MARK NOWLIN / THE SEATTLE TIMES

Unique requirements for safeguarding aircraft

Cyber-physical systems are ones that integrate physical components through computation and networking, and they present unique challenges and opportunities for cyber defense.

Wherever there are computers, there is the potential for adversaries to attempt to subvert them for their own purposes.

First the challenge: cyber-physical systems like aircraft are typically more resource constrained—including in connectivity—than desktop and enterprise systems (and even mobile systems). This means that desktop and enterprise security solutions relying on spare computing power, storage and always-on high-bandwidth networking, generally cannot be used on cyber-physical systems. This complicates the problem for cyber defense.

But here's the opportunity: cyber-physical systems are generally designed for a specific purpose and to interact with the physical world. In other words, their behaviors tend to be designed to achieve a physical result.



Boeing rotorcraft test pilot Roger Hehr (left) reviews security features following a successful High-Assurance Cyber Military Systems flight test on the Unmanned Little Bird helicopter. Boeing photo

Application domains: Transportation

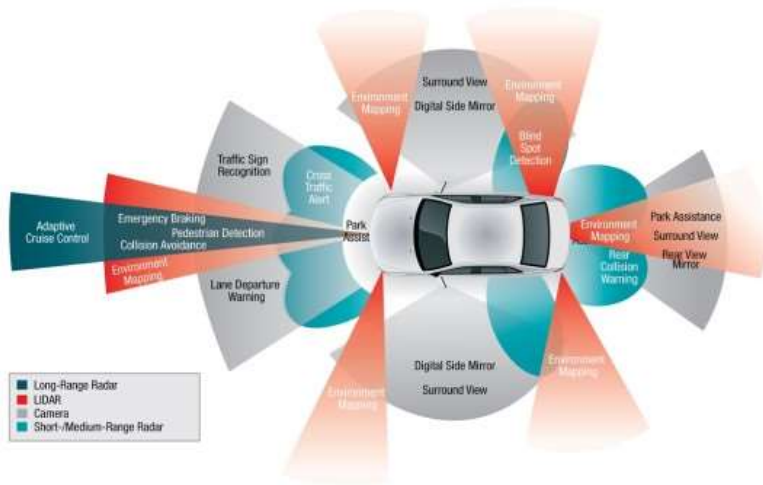

Safety, security, and control of autonomous cars

- Connected vehicles.
- Autonomous fleets/ride sharing.
- Traffic management





Application domains: Energy



- Smart buildings.
- Energy-efficient operation.



- Smart homes.
- EV charging/solar rooftops



- Reliable and resilient electricity grid.
- Micro grids.

Application domains: Healthcare + Biomedical



- Electronic patient record management.
- In home healthcare delivery.



Health and well being monitoring devices.

WIRELESS IMPLANTABLE MEDICAL DEVICES

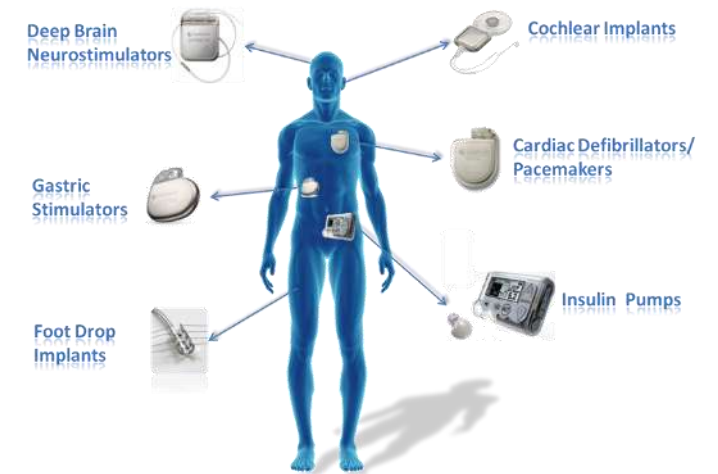

Safety, and security of medical devices and health management systems.

Application domains: Critical Infrastructure



- Water & waste management.
- Storm-water/flood control.



Structural health
monitoring



Utility infrastructure- Gas,
Electricity, Steam.

Application domains: ... and many more



Agriculture



Manufacturing



Industrial Control

Characteristics of CPS

- Pervasive computation, sensing and control
- Networked at multi- and extreme scales
- Dynamically reorganizing/reconfiguring
- High degrees of automation
- Dependable operation with *potential* requirements for high assurance of reliability, safety, security and usability
- With / without human in-the-loop
- Conventional and unconventional substrates / platforms

Closing the loop

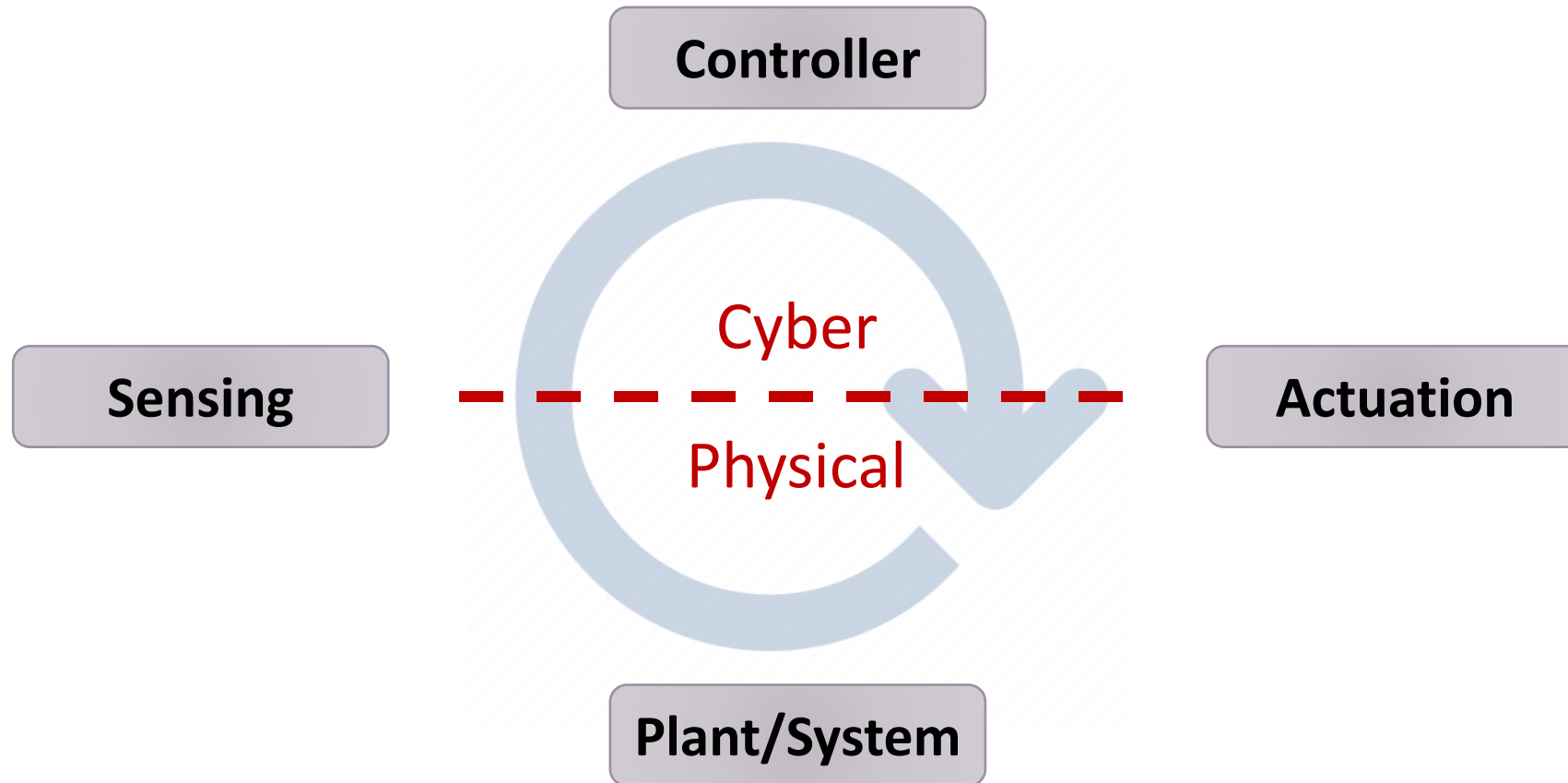

Human in the loop

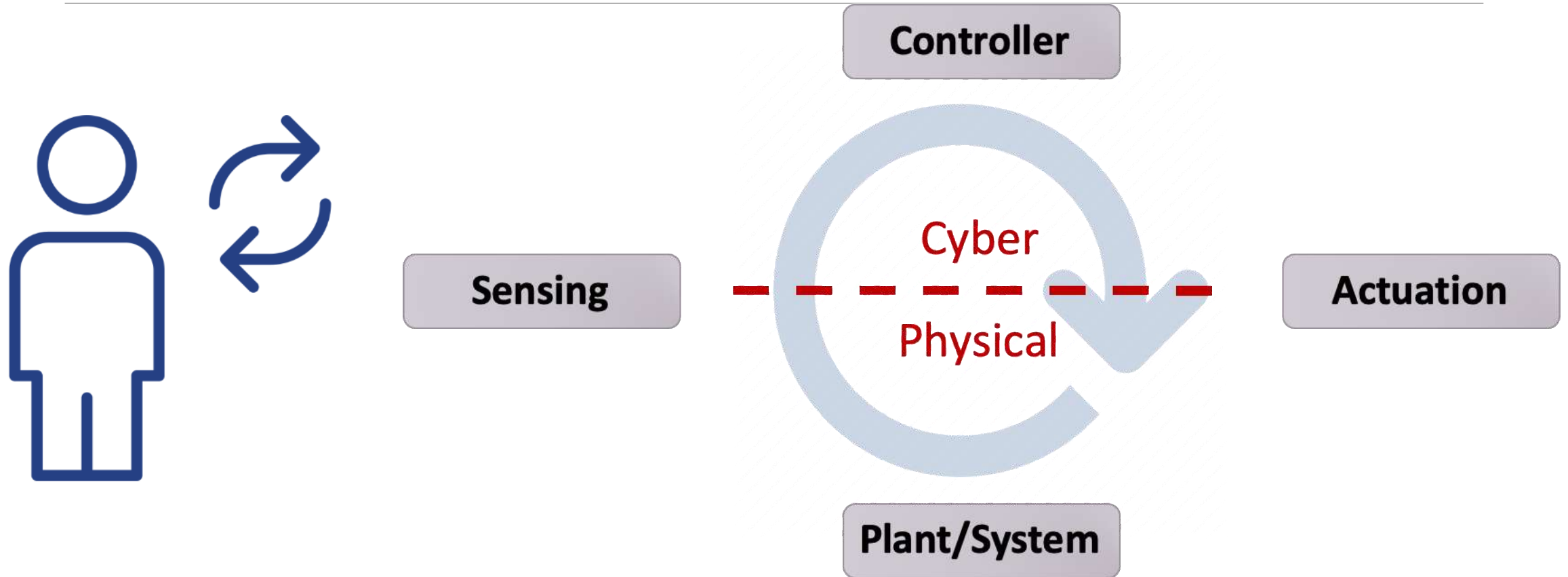

Cyber-Physical Systems

Deeply integrating

computation, communication, control, **and humans**

into **physical systems**

❓ **Physical** = some tangible, physical device or system + environment

❓ **Cyber** = computational + communicational

Cyber-Physical Systems - Goals

Transform how we interact with the physical world

Fusion of physical and computational sciences

Produce significant impact on society

Why is CPS hard ?

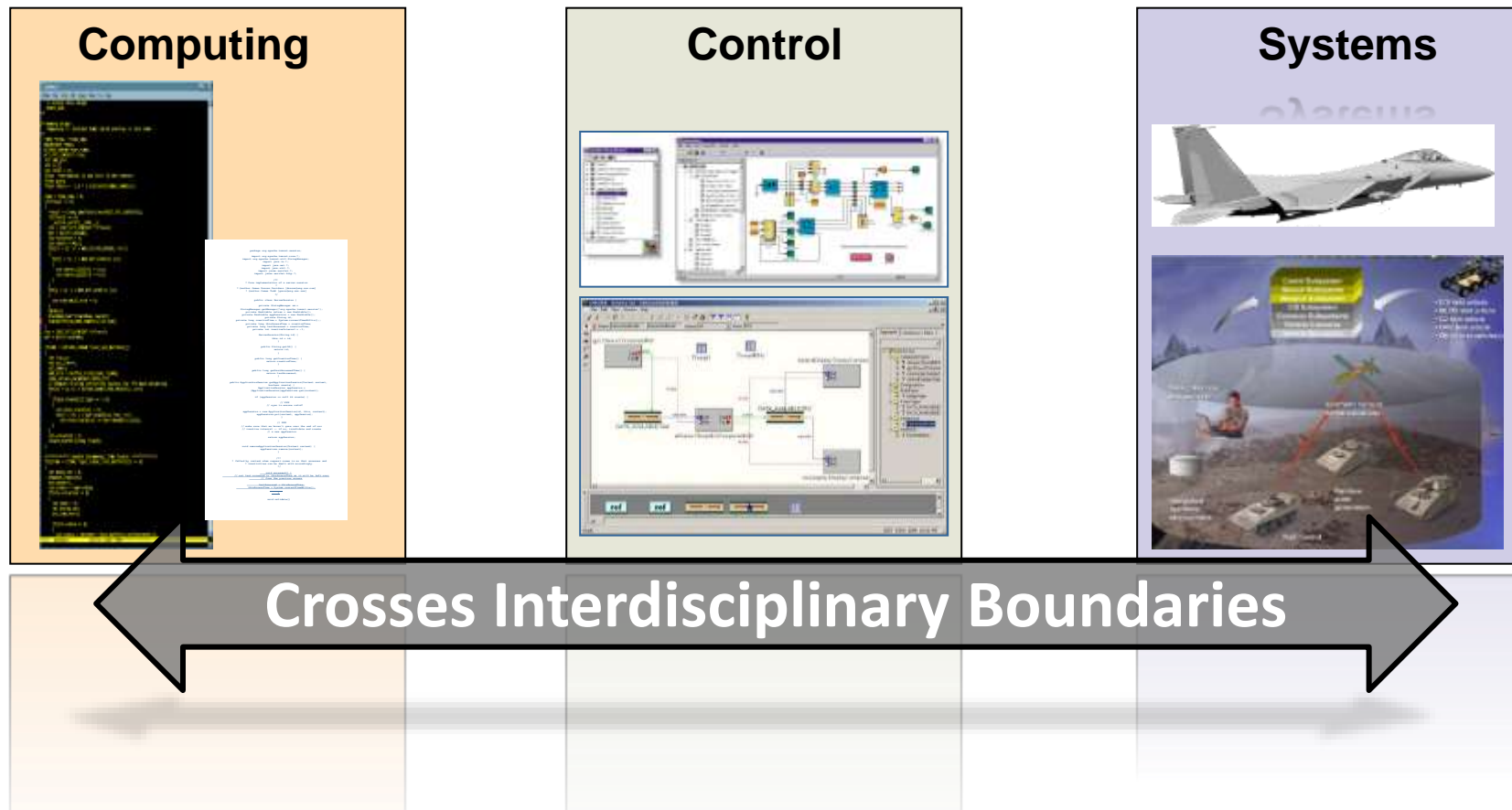

Why is CPS hard ?

- Disciplinary boundaries need to be realigned
- New **fundamentals** need to be created
- New **technologies and tools** need to be developed
- Education need to be restructured

Why is CPS hard ?

- Disciplinary boundaries need to be realigned
- New **fundamentals** need to be created
- New **technologies and tools** need to be developed
- **Education needs to be restructured**

Hmmm, I wonder if there is a course which is trying to achieve this?

what is this course about ?

Principles of **Modeling** for Cyber-Physical Systems

Lets break it down..

1. What are Cyber-Physical Systems ?
2. **What do you really mean by modeling ?**
3. What principles am I going to learn about ?

Modeling types: Physical modeling



Modeling types: Functional/compositional modeling

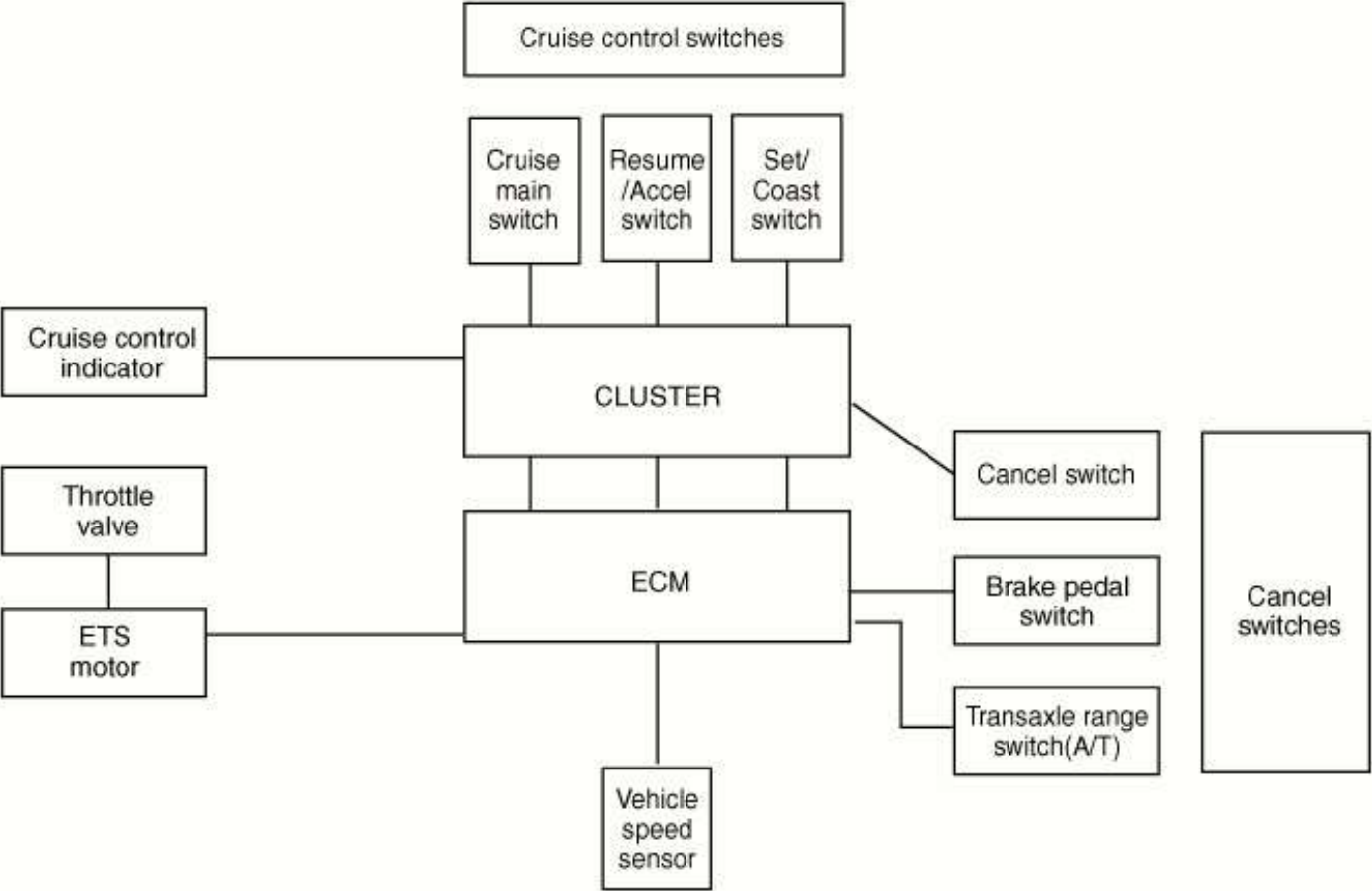

Do you know of any tools for functional modeling ?



Modeling types: Mathematical modeling

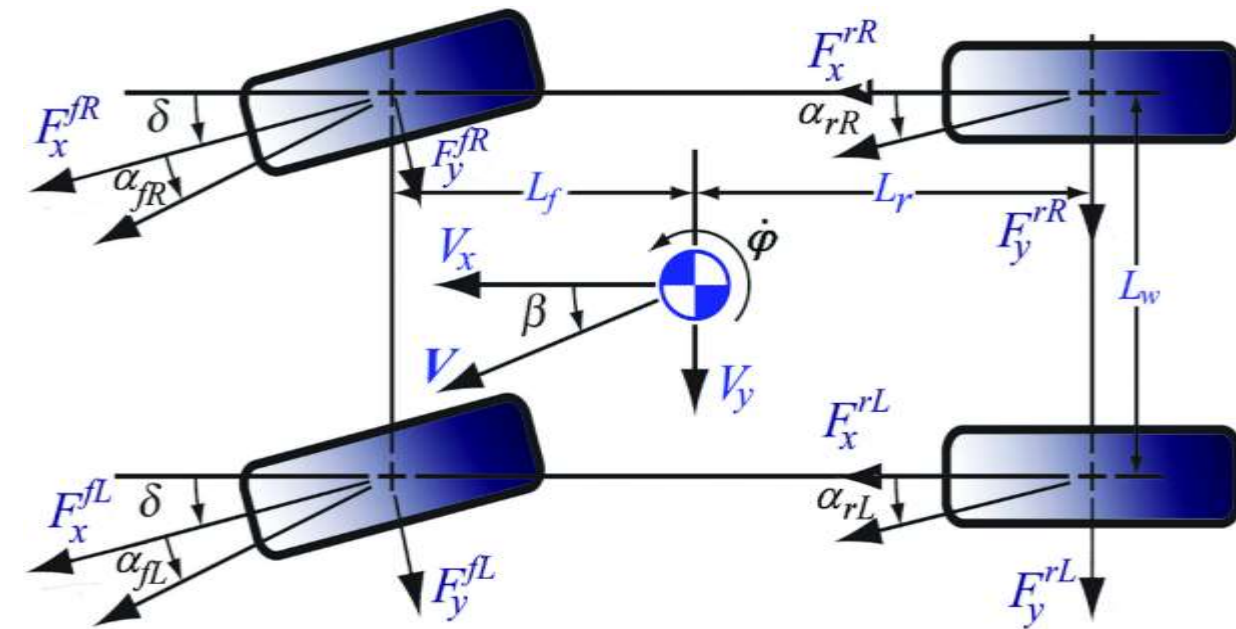

$$\begin{aligned} \dot{v}_x &= \frac{1}{m} \left[(F_x^{fL} + F_x^{fR}) \cos \delta - (F_y^{fL} + F_y^{fR}) \sin \delta + (F_x^{rL} + F_x^{rR}) + \dot{\phi} v_y \right], \\ \dot{v}_y &= \frac{1}{m} \left[(F_y^{fL} + F_y^{fR}) \cos \delta + (F_x^{fL} + F_x^{fR}) \sin \delta + (F_y^{rL} + F_y^{rR}) - \dot{\phi} v_x \right], \\ \ddot{\phi} &= \frac{1}{I_\phi} \left(L_f (F_x^{fL} + F_x^{fR}) \sin \delta + L_f (F_y^{fL} + F_y^{fR}) \cos \delta - L_r (F_y^{rL} + F_y^{rR}) \right. \\ &\quad \left. + \frac{L_w}{2} (F_x^{fR} - F_x^{fL}) \cos \delta + \frac{L_w}{2} (F_x^{rR} - F_x^{rL}) + \frac{L_w}{2} (F_y^{fL} - F_y^{fR}) \sin \delta \right), \end{aligned}$$

Modeling types: Computational modeling

Time: 0.910253

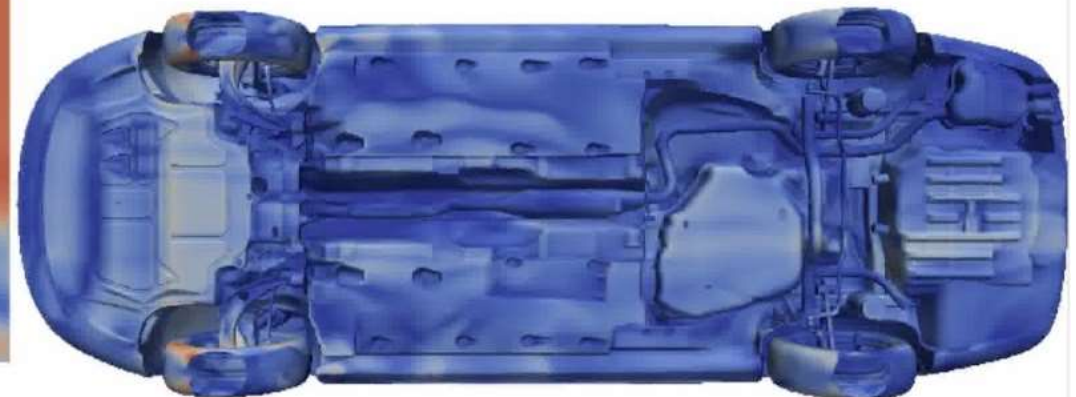
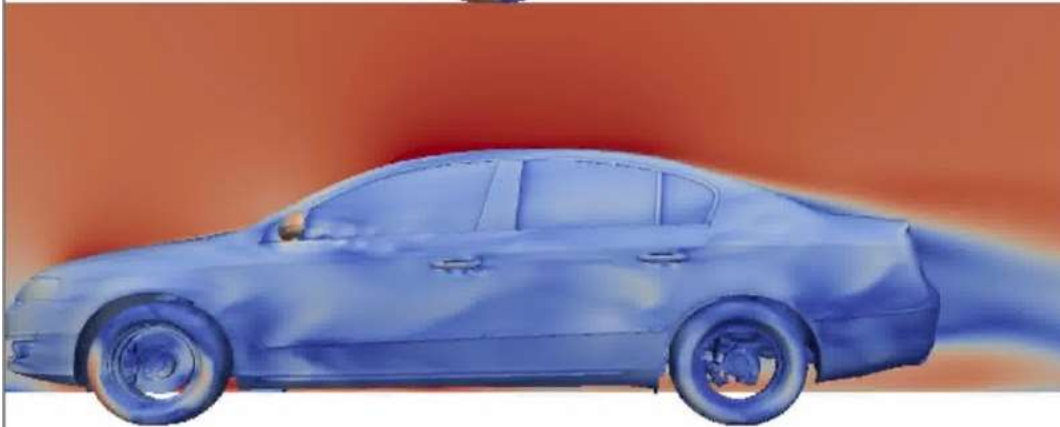
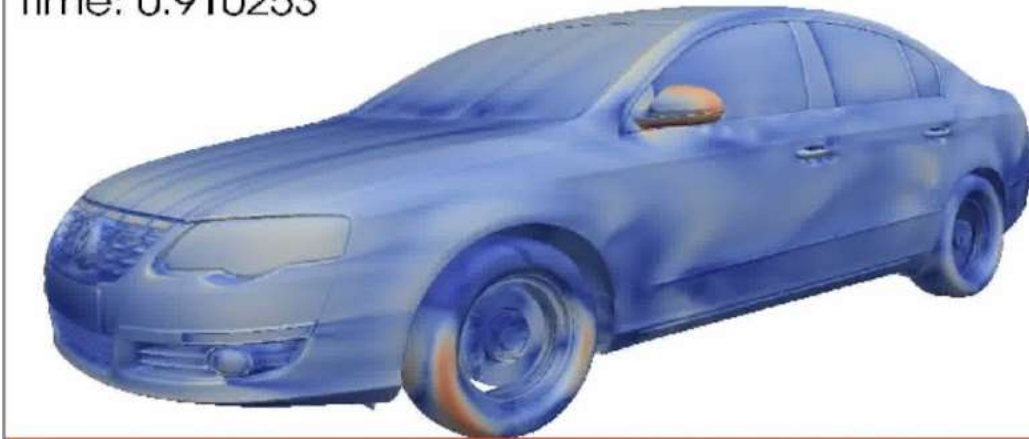

A word about mathematical models

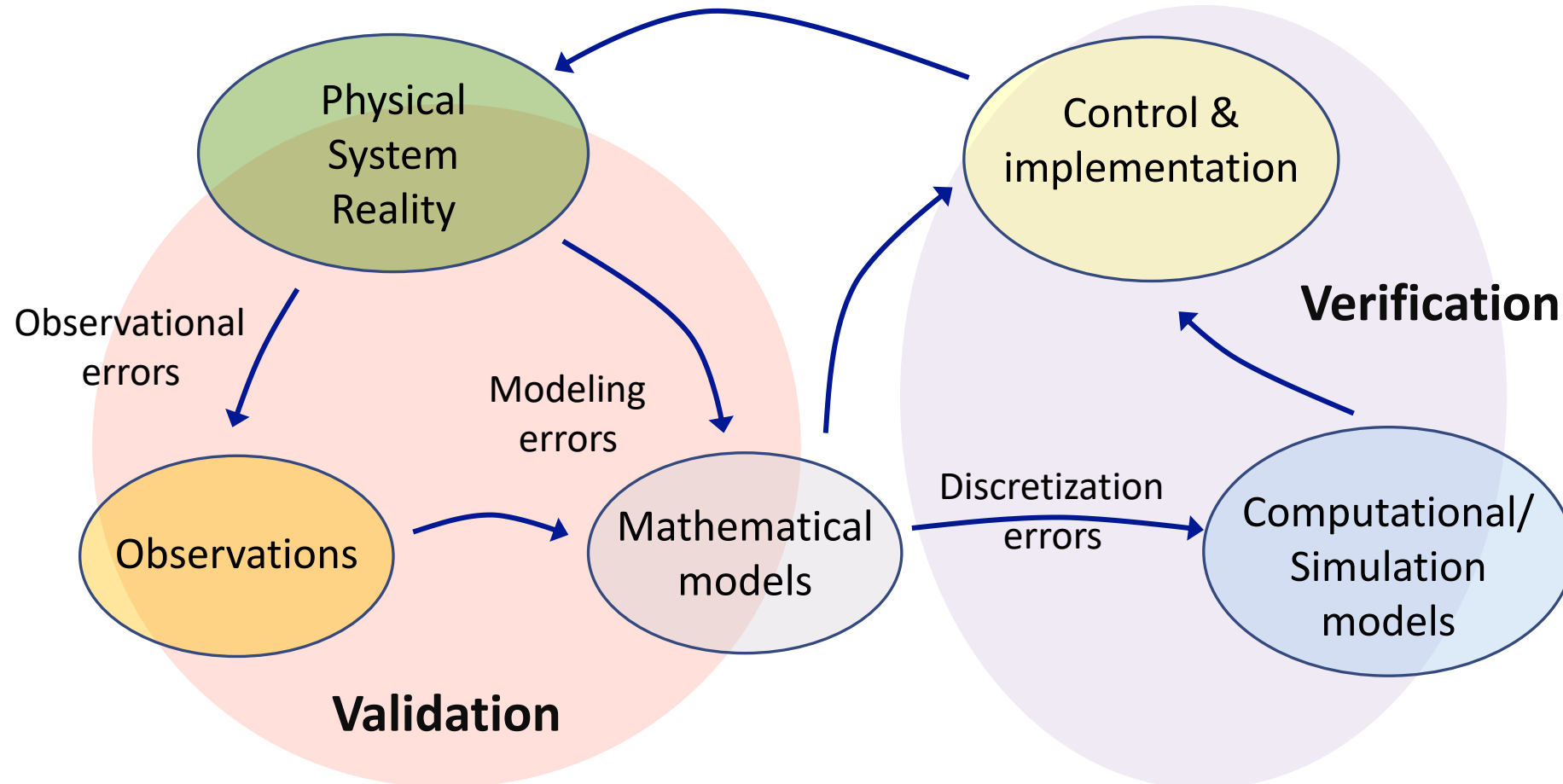

“Essentially all models are wrong, but some are useful”

- George E.P. Box (statistician)

....this course is about building useful models.

This course: Three CPS domains

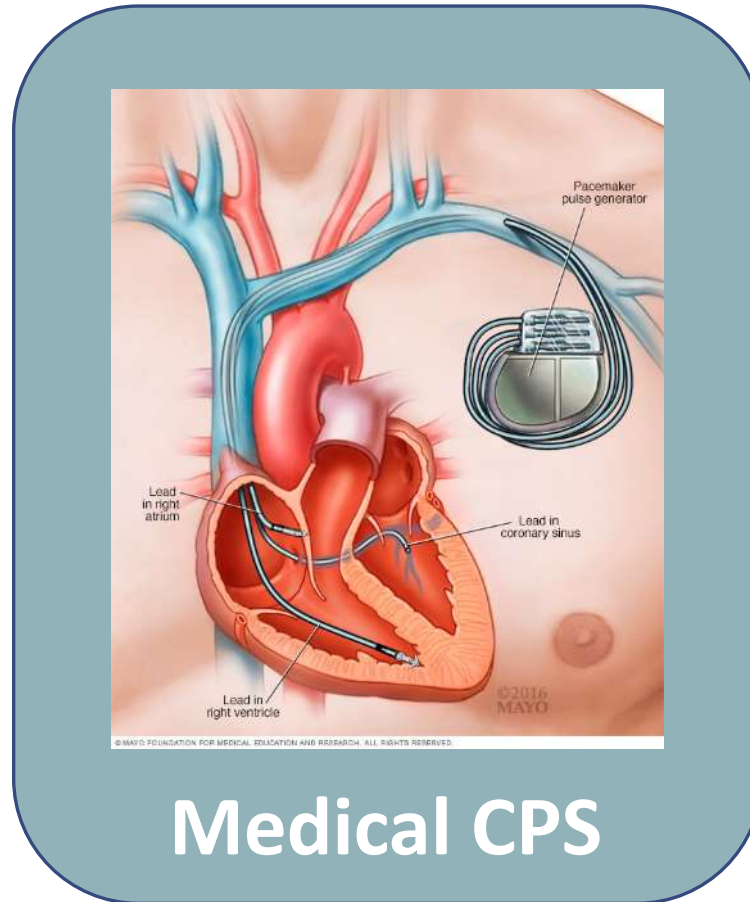
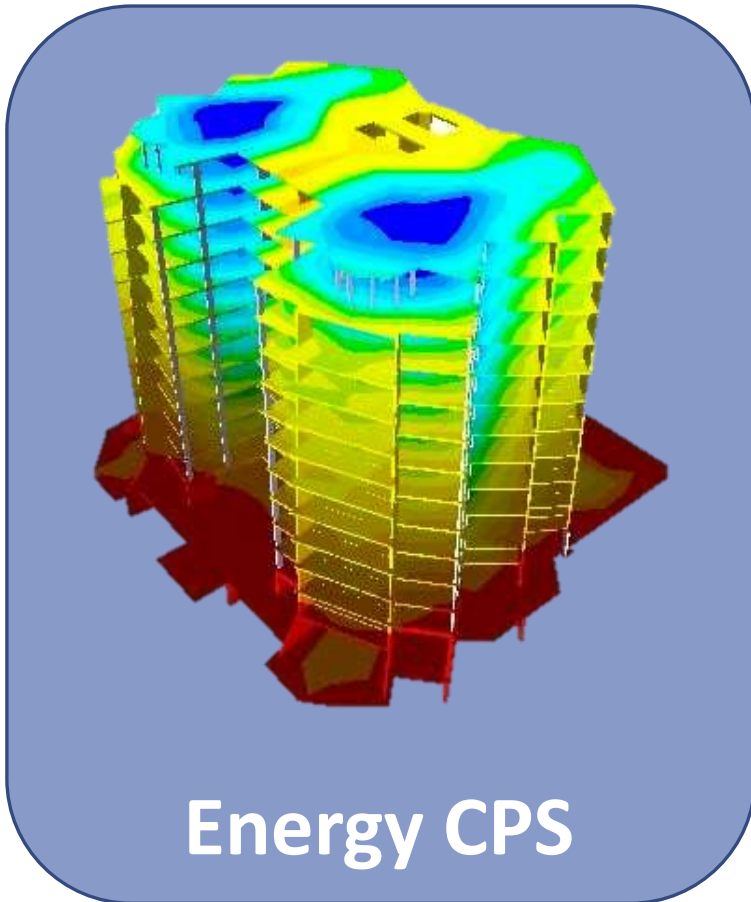

Smart Cities

Smart and
Connected Health

Autonomous
Systems

CS

ECE

SIE

Civil

ME

LINK
LAB

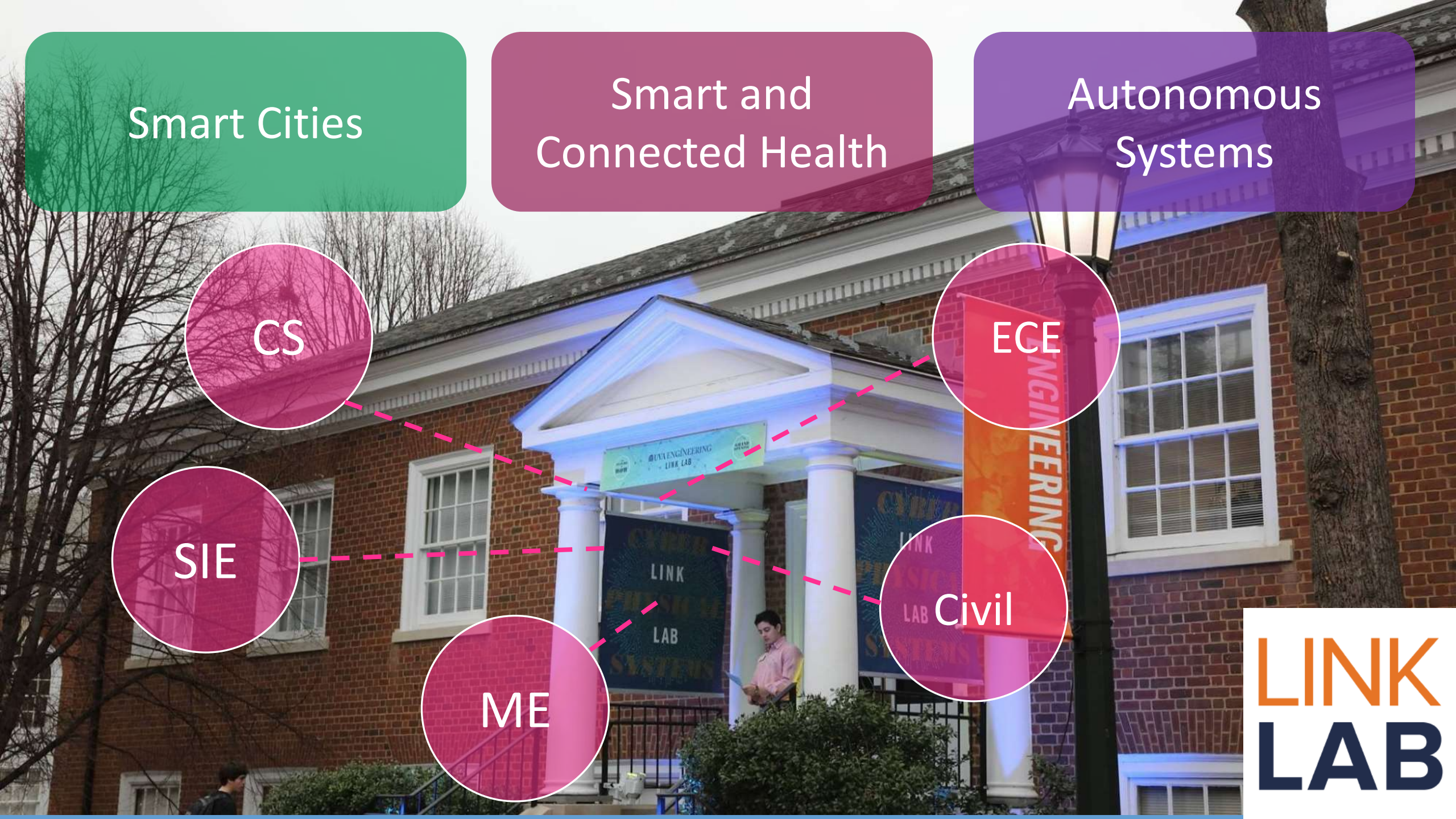

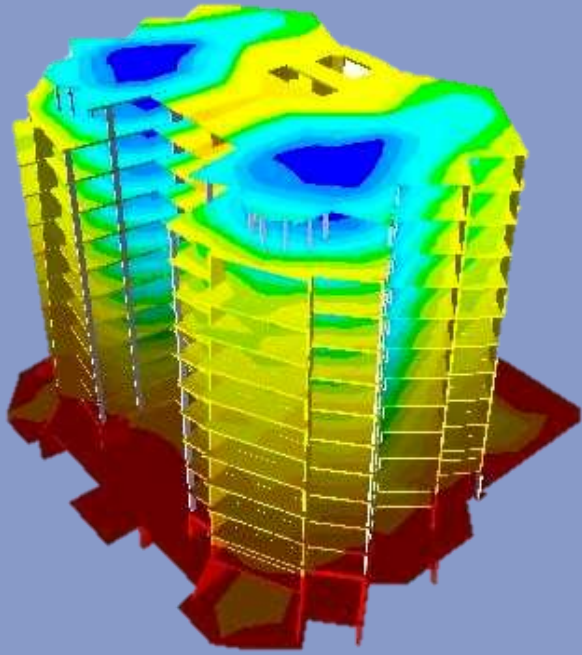

Energy CPS

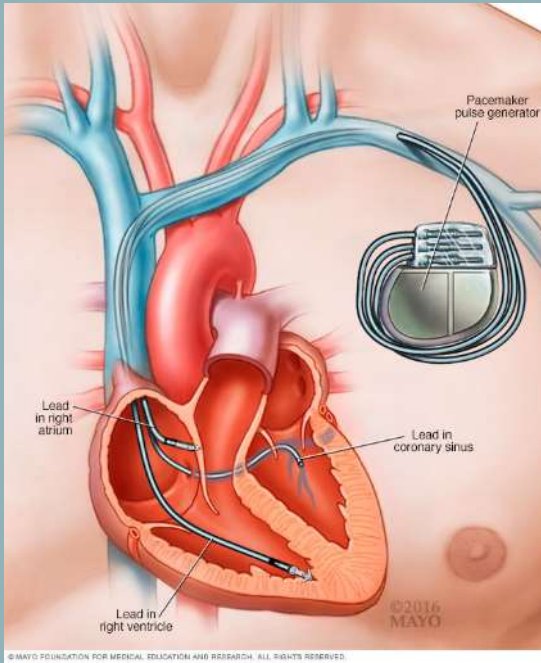

Medical CPS

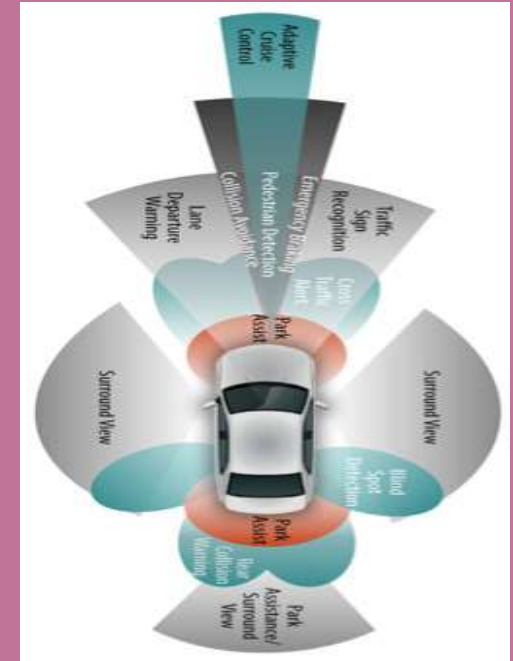

Automotive CPS

White-box
State-space

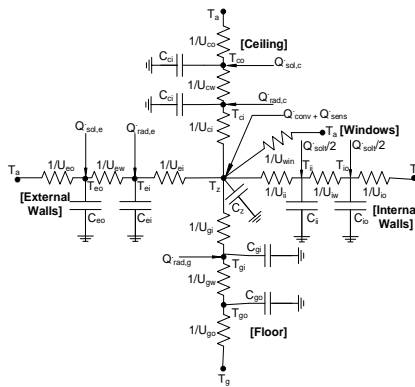

Timed
Automata

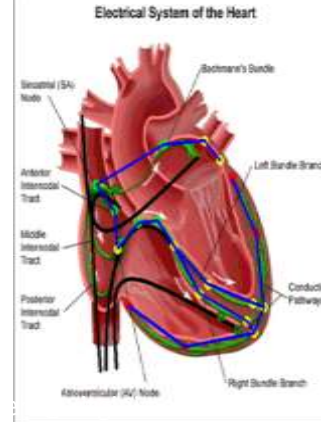

Data-driven

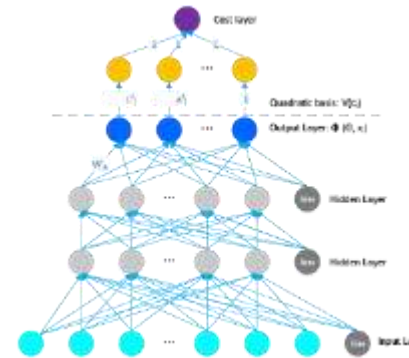

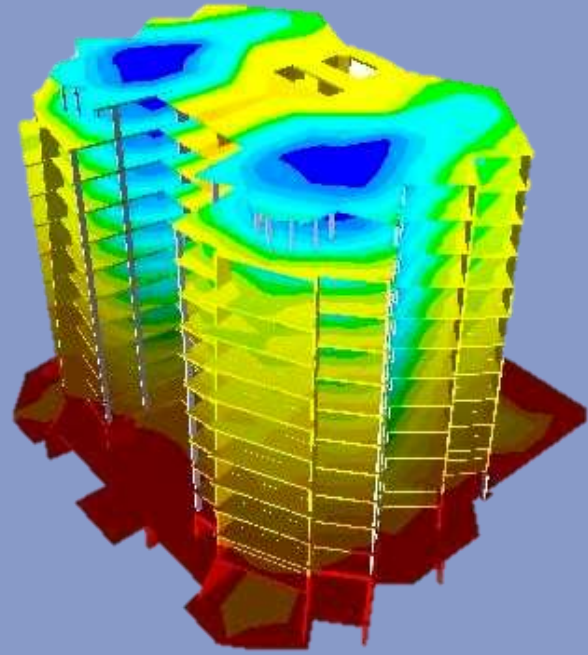

Energy CPS

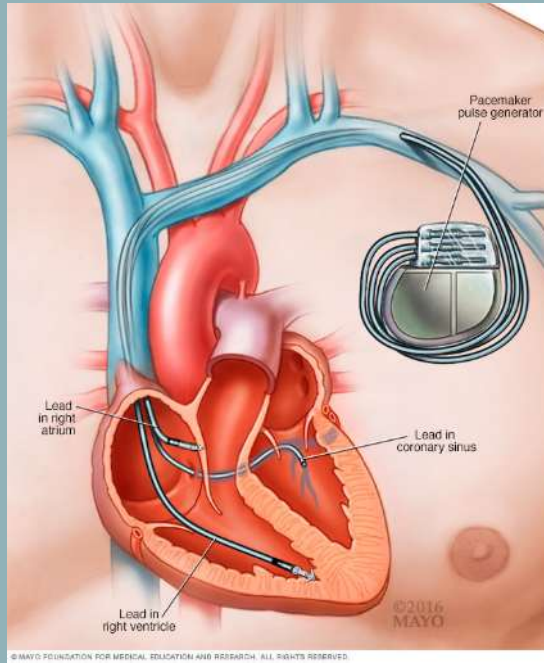

Medical CPS

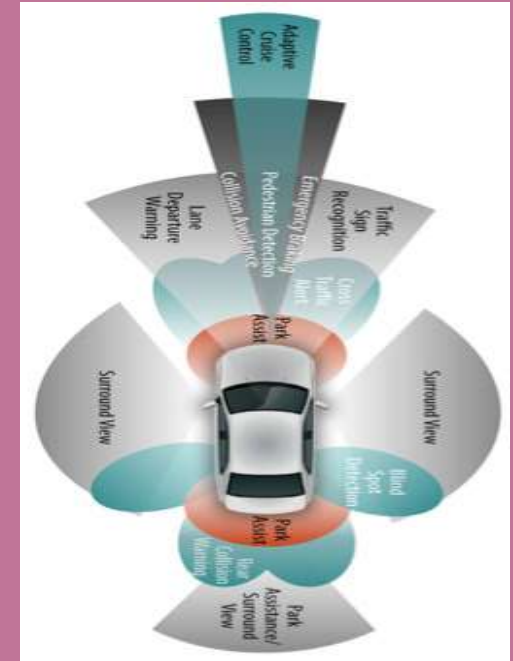

Automotive CPS

EnergyPlus



Matlab

UPPAAL

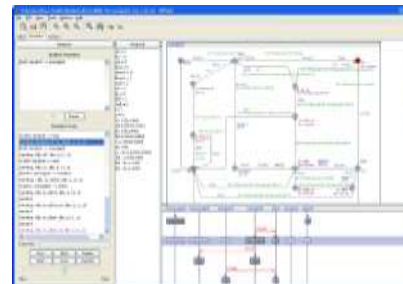

Simulink

CARLA



Matlab/Python



A blue-tinted wireframe image of a multi-story building with a curved roofline, serving as a background for the slide.

Energy CPS Module

2014 Officially Hottest Year on Record

2015 Is Officially the Hottest Year

EARTH

July Was the Hottest Month in Recorded History

After a record-breaking heat wave in Europe and the Arctic, last month edged out July 2016

ON RECORD FOR THE U.S.

2018 Was the 4th Warmest Year on Record, Berkeley Group Announces

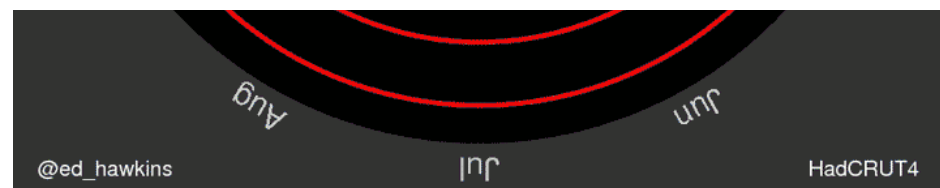
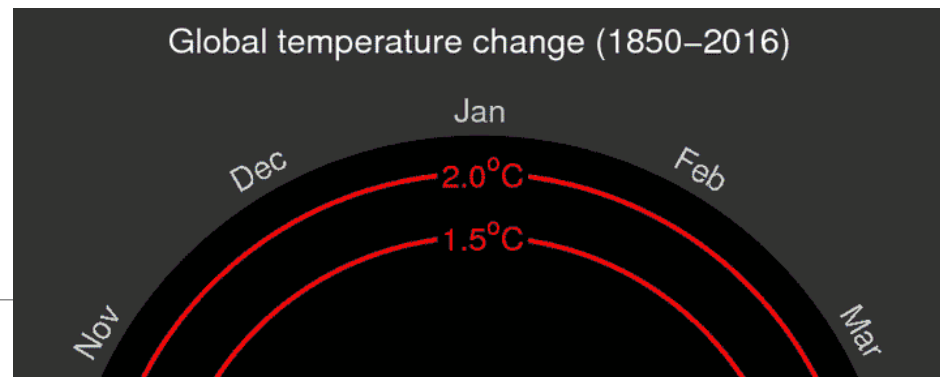

Price Volatility: Summer peak

Nominal price: \$25/MWh

Peak Price: \$800/MWh

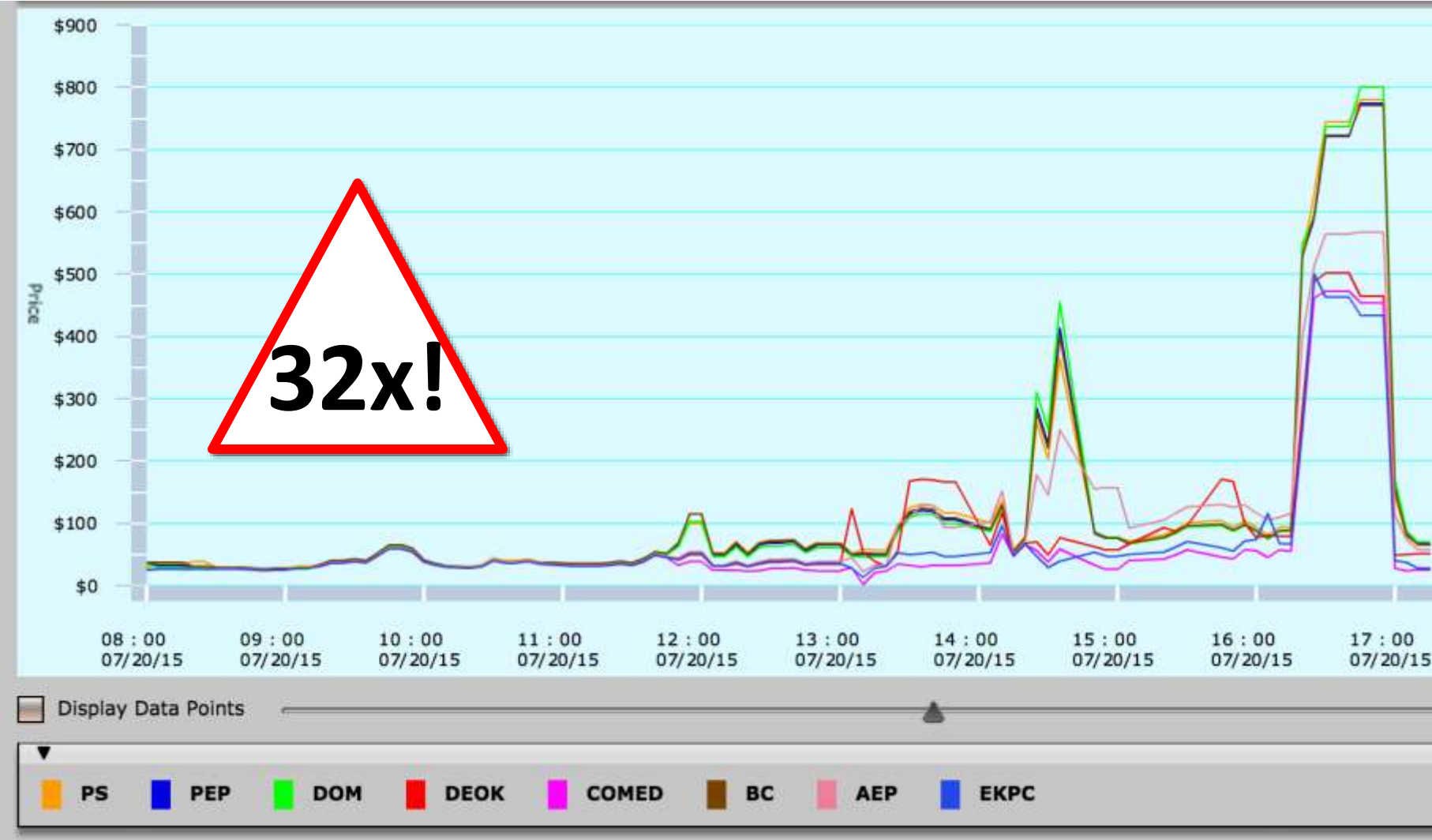

"All kilowatts are not created equally"

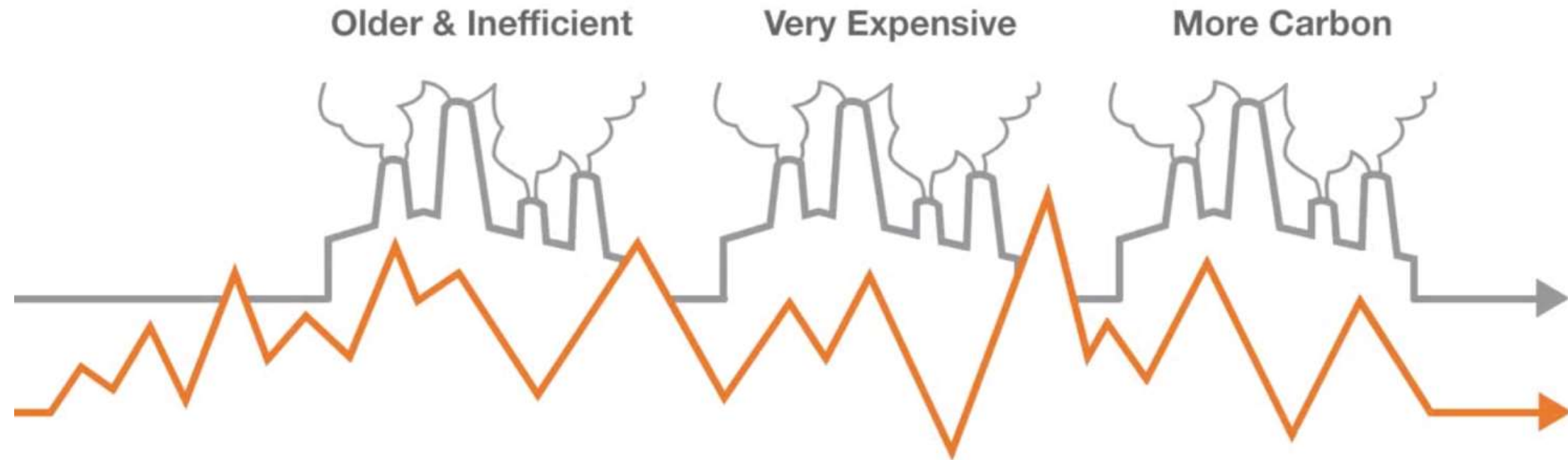

AUGUST 1, 2019

Heat wave results in highest U.S. electricity demand since 2017

Hourly electricity demand in the Lower 48 states (Jul 7-Jul 27, 2019)
gigawatts (GW)

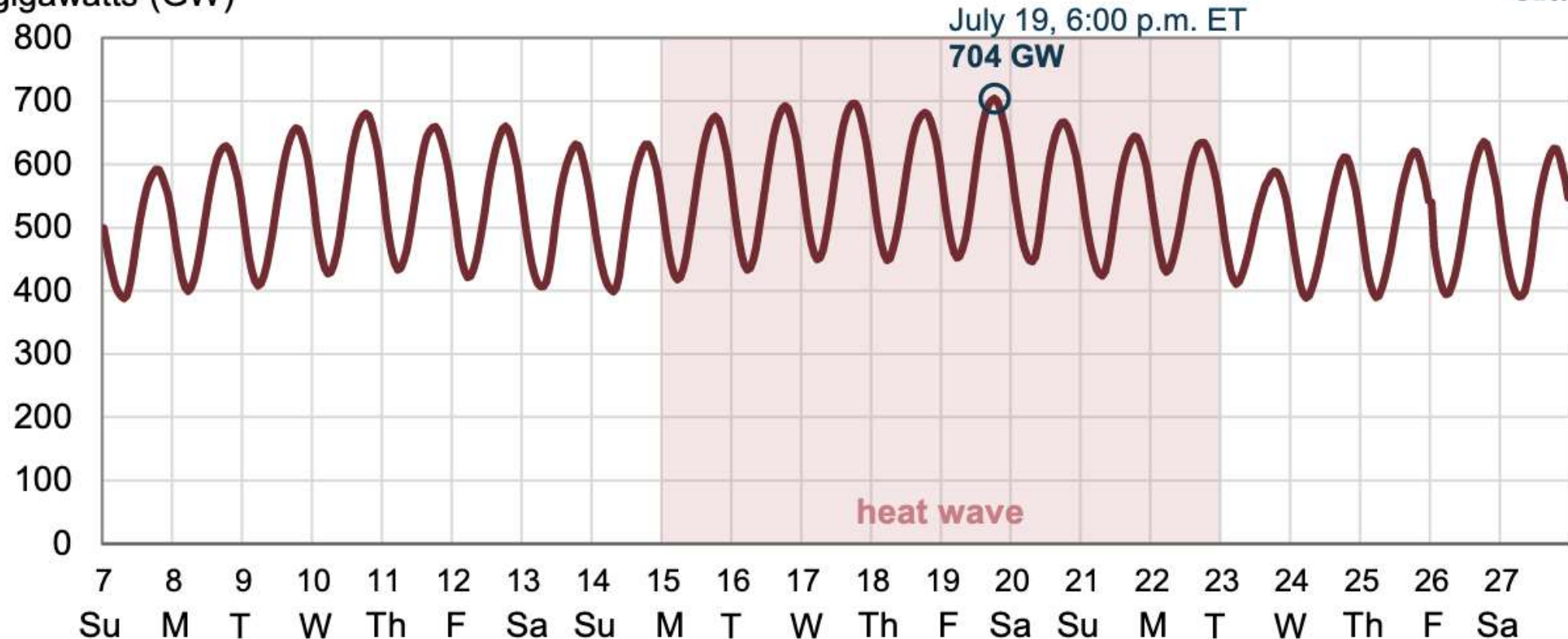

Source: U.S. Energy Information Administration, [U.S. Electric System Operating Data](#)

Price Volatility: Winter peak

Nominal price: \$31.21/MWh

Peak Price: \$2,680.21/MWh

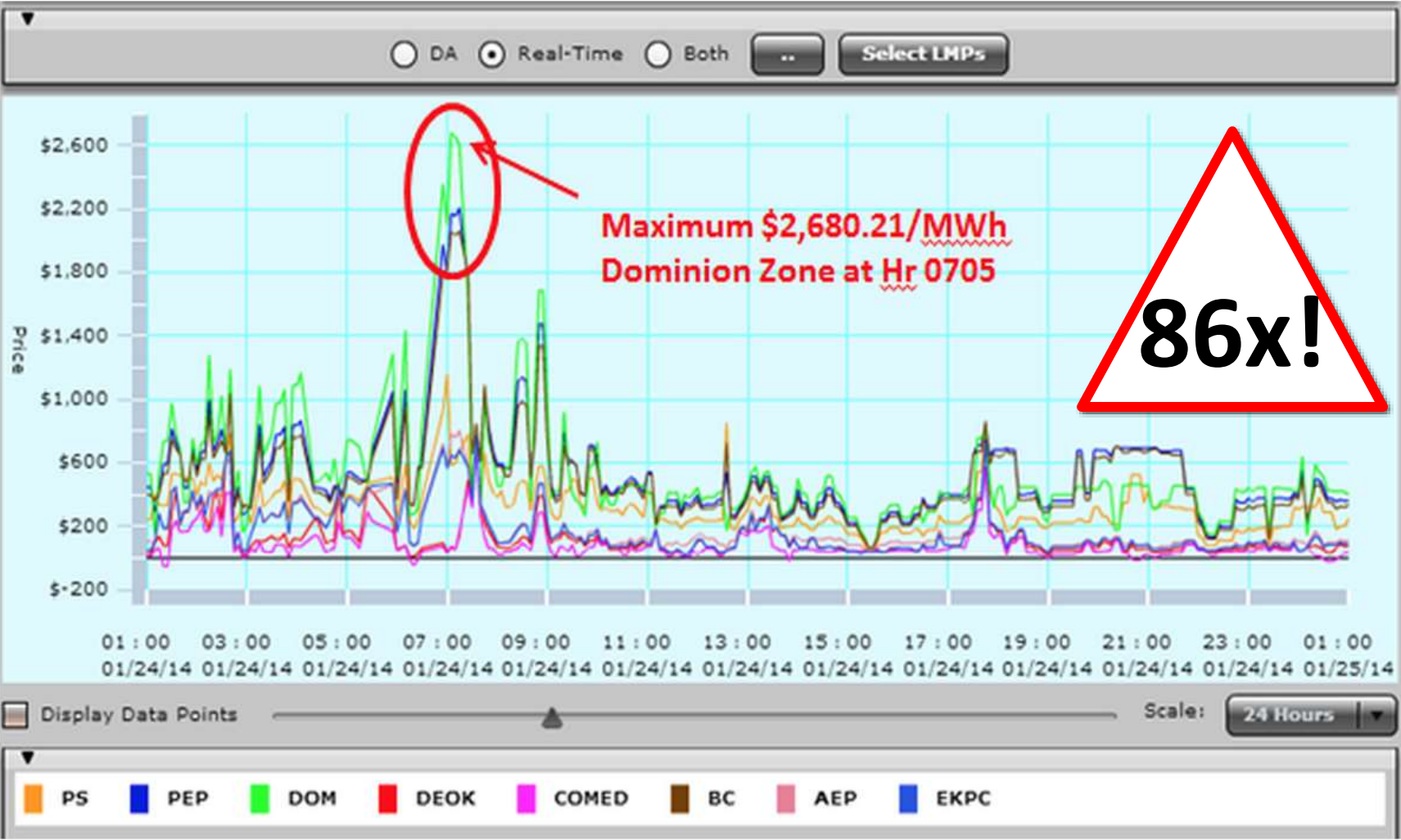

Price volatility is the new normal

PJM (ISO) Locational Marginal Prices (LMPs) example

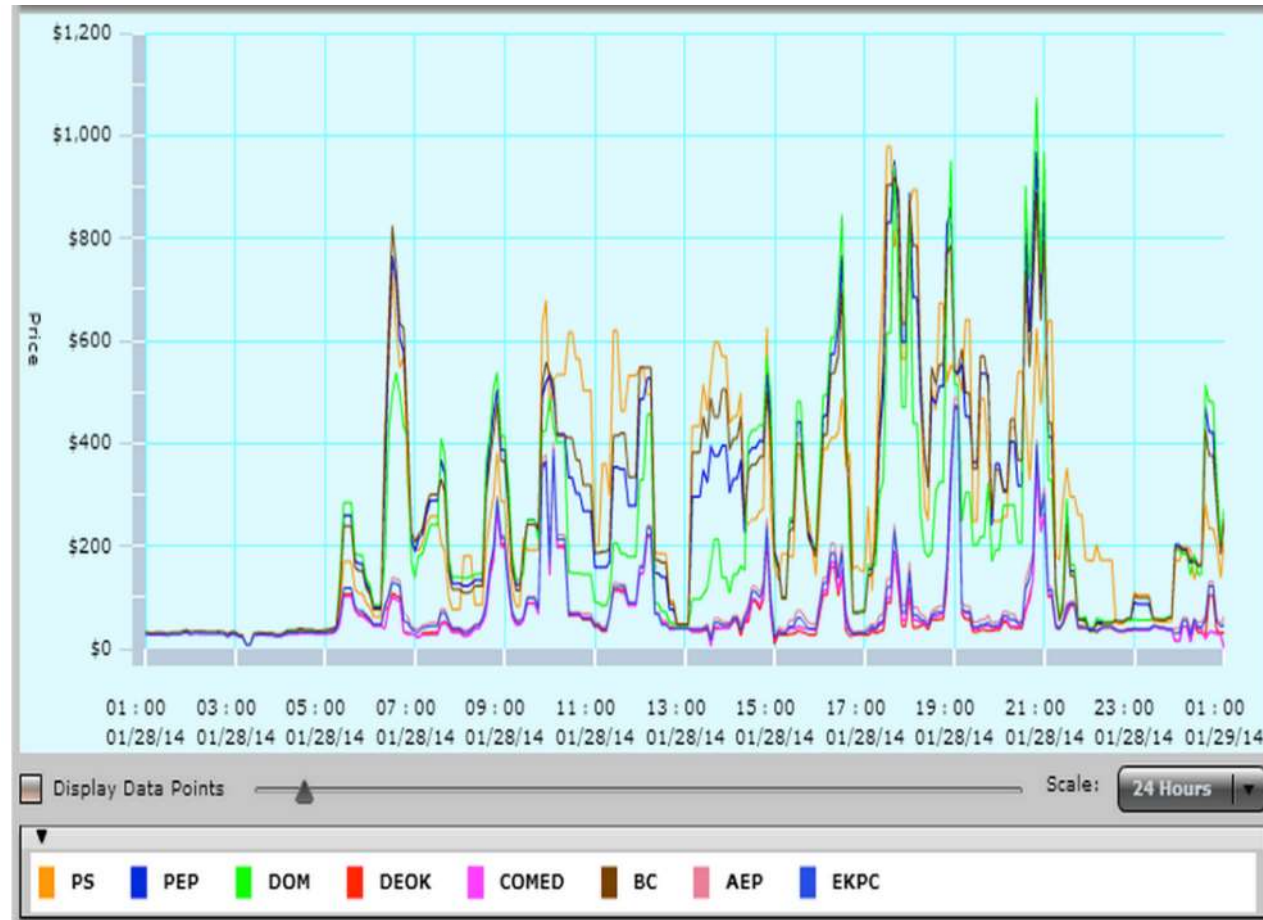

At large scales: University Campus

An aerial photograph of a large university campus, showing a dense collection of buildings, courtyards, and green spaces. The image is used as a background for a presentation slide. Overlaid on the image are five text boxes with white backgrounds and blue borders, containing statistics about the campus's energy and data infrastructure. The text is in a bold, sans-serif font, with the numbers in black and the units and descriptions in blue.

72 MW
Peak (UCAP)

187
Buildings

300,000
SCADA Tags

4 Million
Gallons of chilled water (@42F)

Economic incentives for model based control

~\$28M
Annual Electricity Bill

In 2011

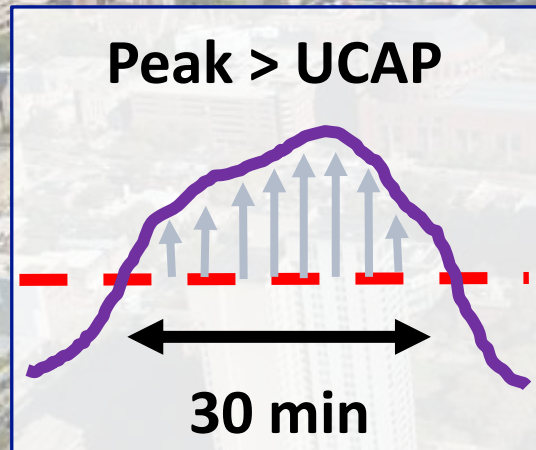

\$720,000
Penalty for 30 minutes

Why focus on Buildings ?

40%

Portion of global energy use

70%

Portion of electricity consumption in
the United States

1/3

Portion of global total CO₂ emissions

Model-Based control for buildings

Traditional rule-based building control

- Sequence of operations or planned steps.
- Pre-defined rules set by building engineers.
- Purely reactive.
- Equipment-level controllers (PID) ensure reference tracking.



21

Took 23 min yesterday

22

Took 42 min today
(but price increased !)

Model-based building control

- Model how the building will response to disturbances (weather, occupants etc.)
- Predictive
- Control design:
 - Energy-efficiency
 - Demand flexibility
 - Fault handling
- Okay to use equipment level PID control

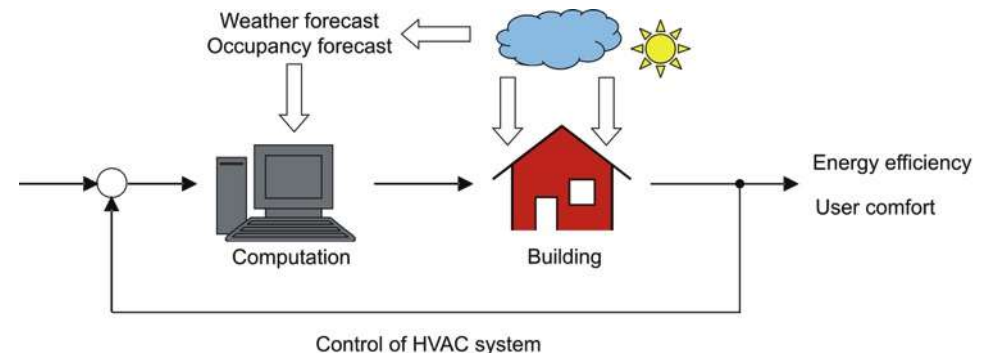

Model Predictive Control (MPC)

The control problem in buildings

Integrated control of:

- Heating
- Cooling
- Ventilation
- Lighting
- Blinds



State-space 'RC' thermal modeling

$$C_{co}\dot{T}_{co}(t) = U_{co}(T_a(t) - T_{co}(t)) + U_{cw}(T_{ci}(t) - T_{co}(t)) + \dot{Q}_{sol,c}(t)$$

$$C_{ci}\dot{T}_{ci}(t) = U_{cw}(T_{co}(t) - T_{ci}(t)) + U_{ci}(T_z(t) - T_{ci}(t)) + \dot{Q}_{rad,c}(t)$$

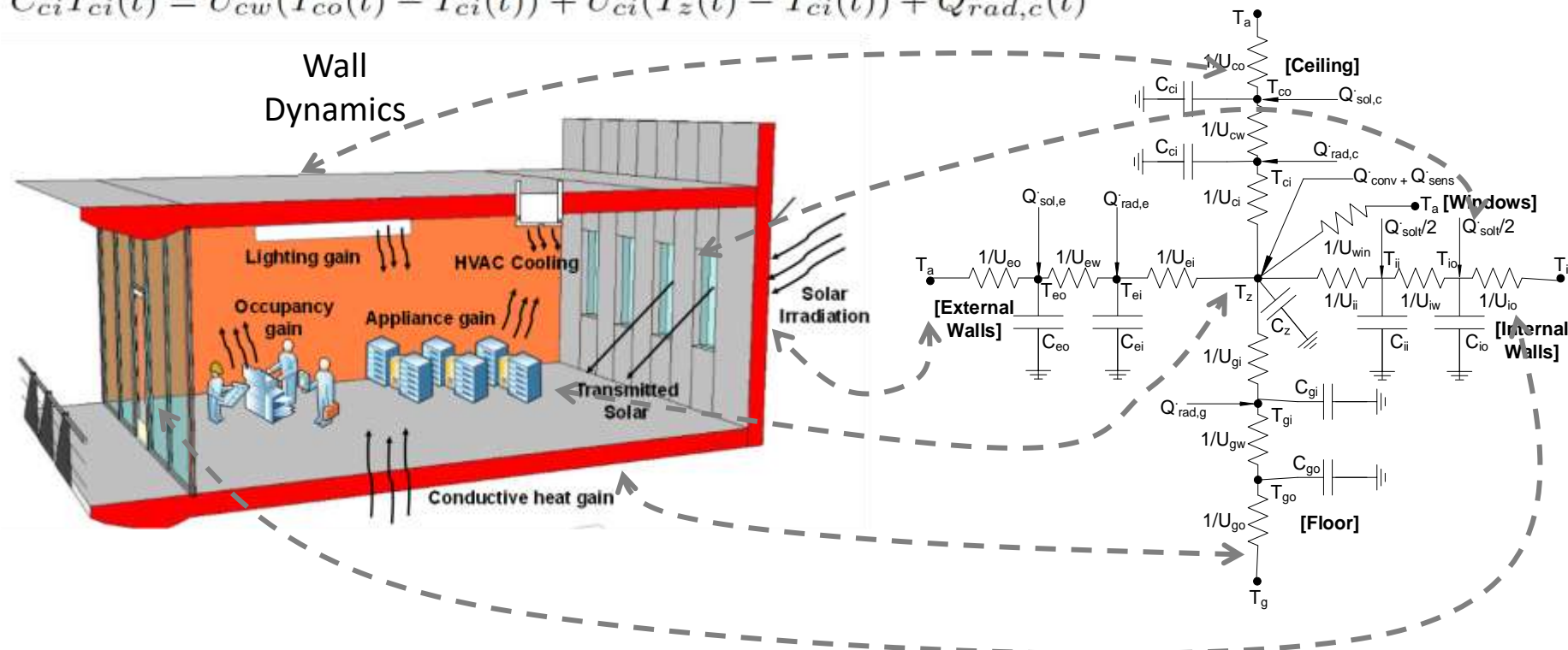

Whole building energy simulation

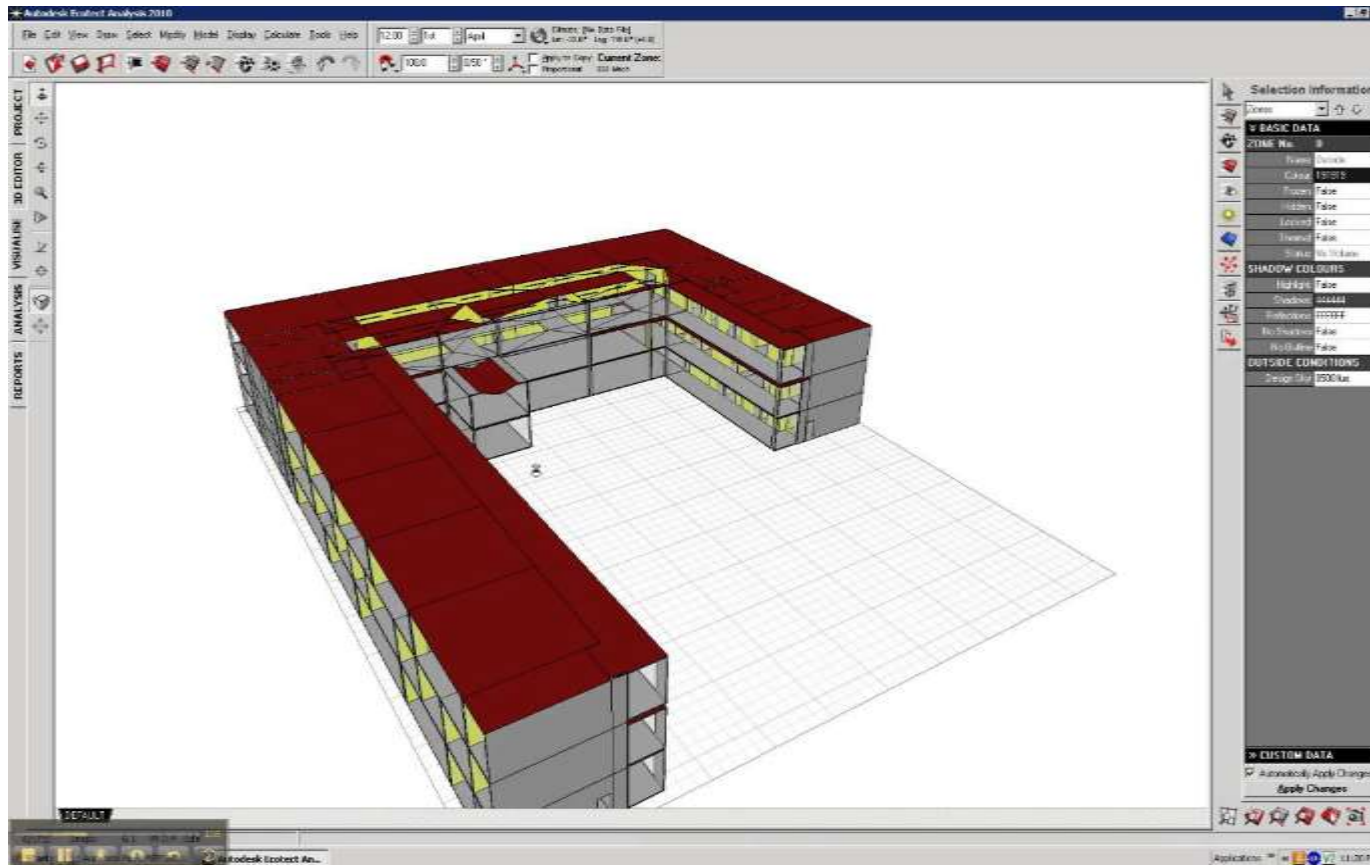

Using EnergyPlus.

Generating input-output data

Modeling a building in MATLAB

Non-linear parameter estimation and model validation

Training Fit

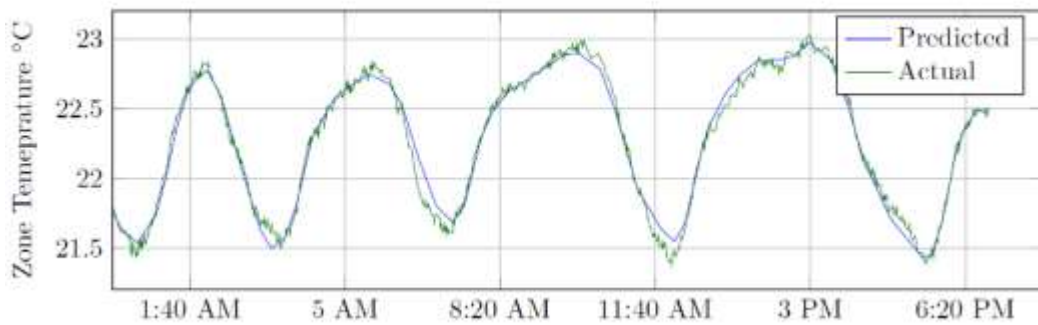

Model Accuracy for Training data

RMSE: 0.062 °C

R2: 0.983

Baseline

Testing Fit

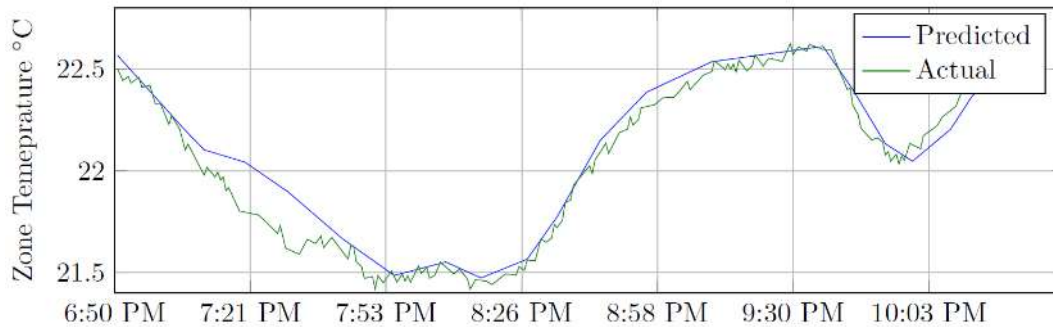

Model Accuracy for Test Data

RMSE: 0.091 °C

R2: 0.948

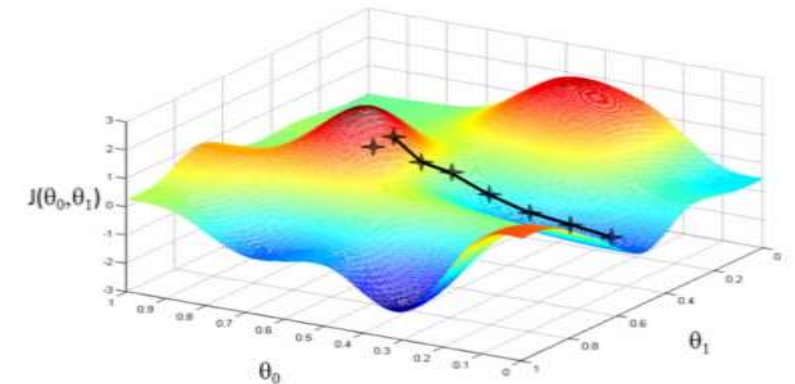

Predictive control

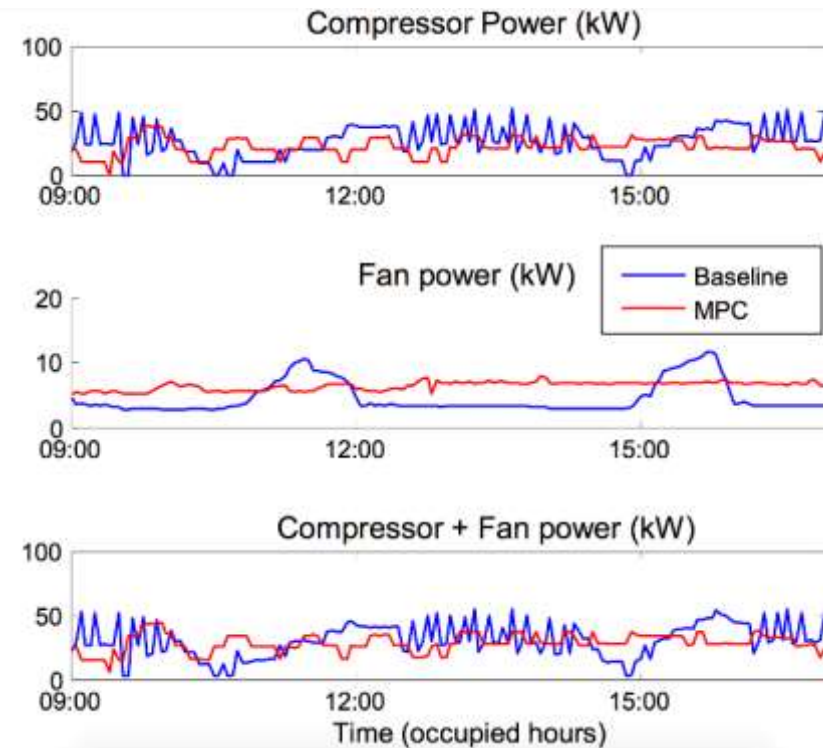



Medical CPS Module

Software related vehicle recalls

| AUTO RECALL | | | |
|--|---|---|---|
| TOYOTA | HONDA | NISSAN | MAZDA |
|  |  |  |  |
| 1.7 MILLION VEHICLES | 1.1 MILLION VEHICLES | 480,000 VEHICLES | 45,500 VEHICLES |



100M+ lines of code
Premium Vehicle

12M lines of code
Android Operating System

24M lines of code
F-35 Fighter Jet

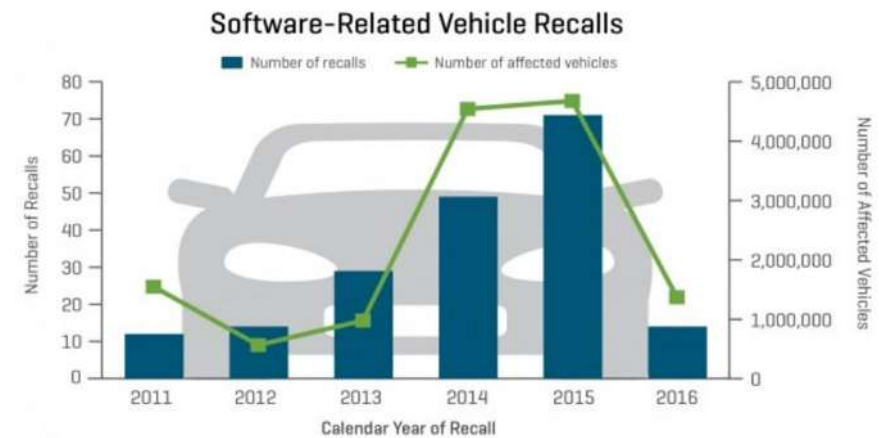

Source: J.D. Power SafetyIQ and NHTSA's safecar.gov

IMPLANTABLE DEVICES RECALL

- Over **600,000** cardiac medical devices recalled from 1990-2000
 - **40%** of which were due to **software issues**
- 2008-12: **15% of all** the medical device recalls due to software



Implantable Pacemaker



Implantable Cardioverter-Defibrillator (ICD)

THE HEART



- Muscle contraction triggered by **electrical signals**



BRADYCARDIA



- Slow **generation** and **conduction** of electrical signals
- Slow heart rate
- Symptom: fainting, dizziness
- Could lead to heart attack



IMPLANTABLE PACEMAKER

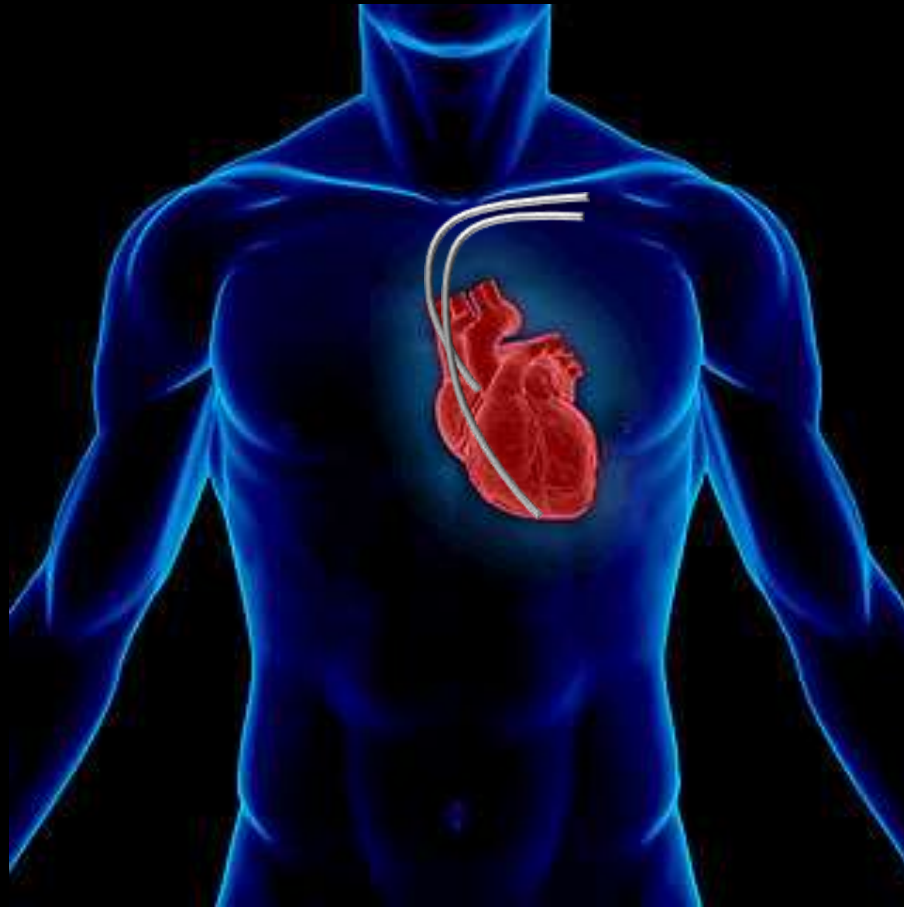

-  leads in heart chambers



IMPLANTABLE PACEMAKER

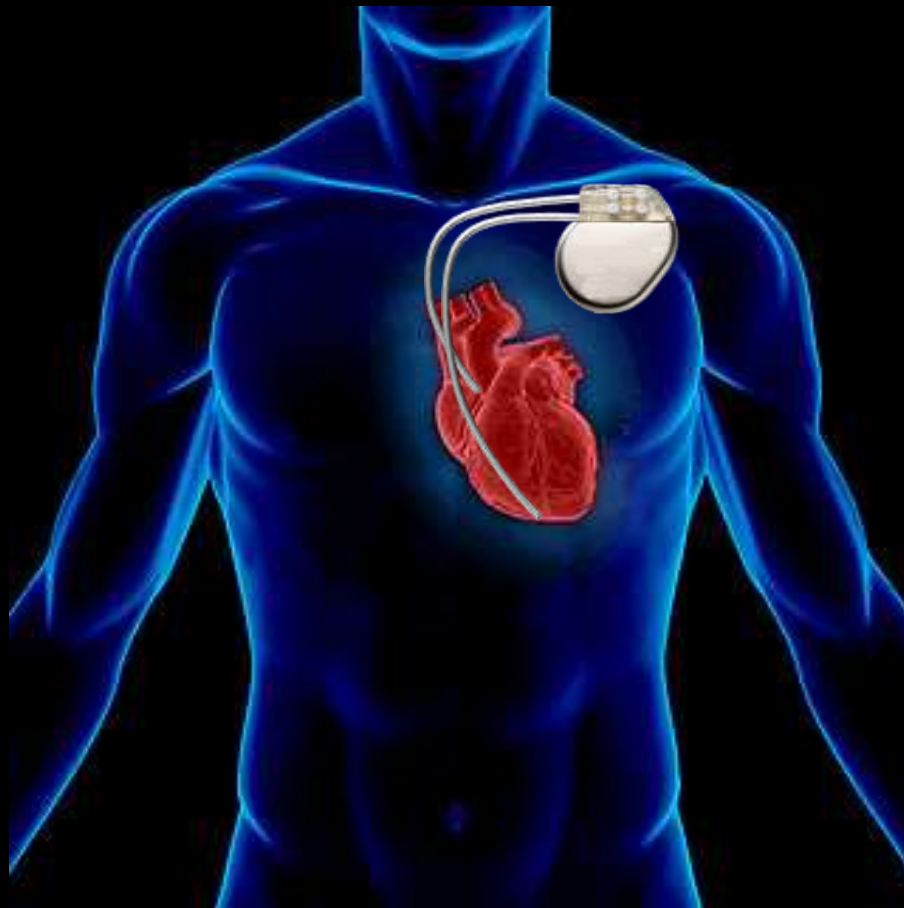

- Two leads in heart chambers
- Deliver electrical signals when heart rate is low

IMPLANTABLE PACEMAKER

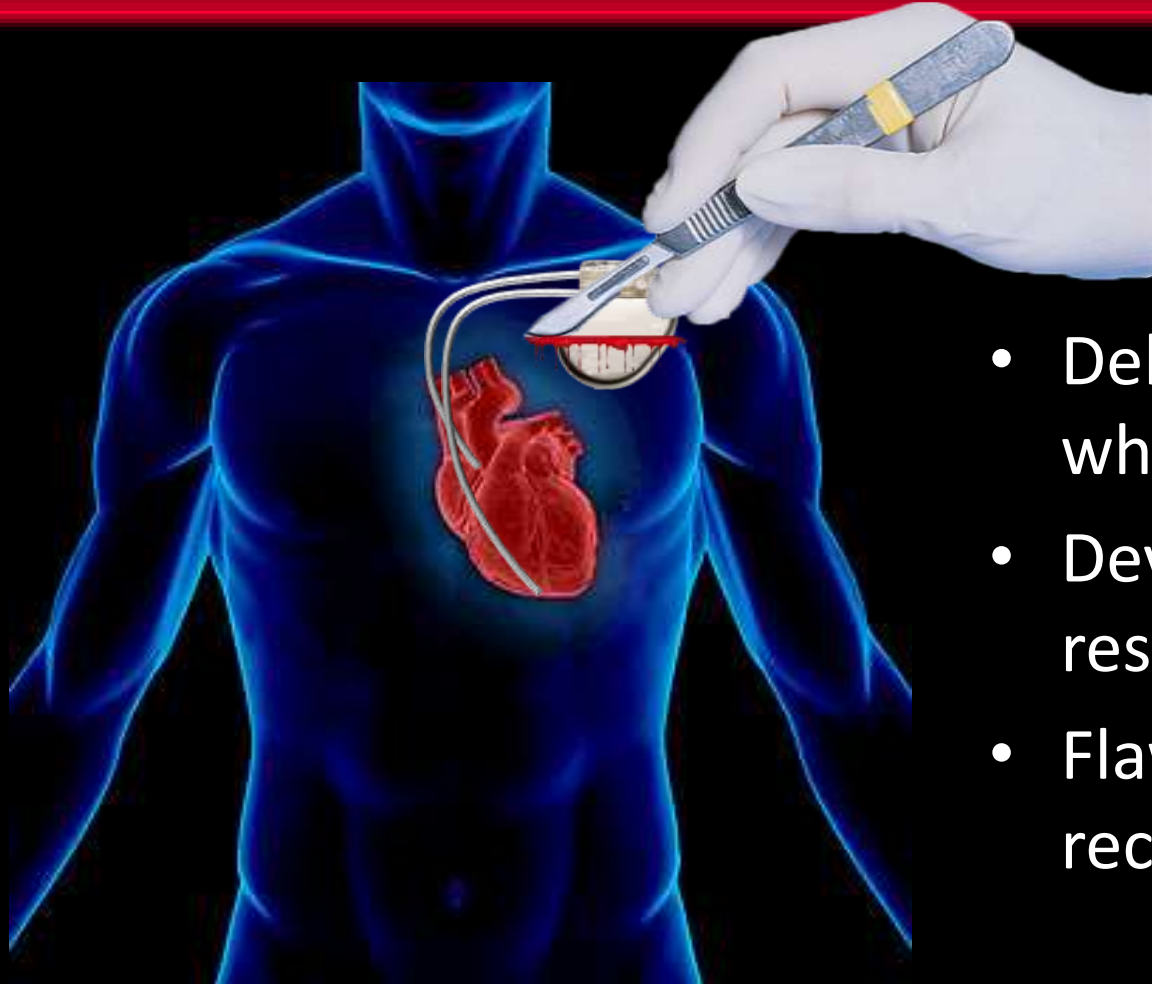

• Delivers electrical signals to leads in heart chambers

- Deliver electrical signals when heart rate is low
- Device malfunction may result in **injury or death**
- Flawed devices are recalled

CHALLENGES



Pacemaker

- Autonomous device with minimum human interaction
- Limited diagnostic/therapy capability
- Its safety must be evaluated within its environment

The physical plant:

- Complex dynamics of the heart
- Interaction between the heart and the body
- Domain knowledge

CLOSED-LOOP EVALUATION

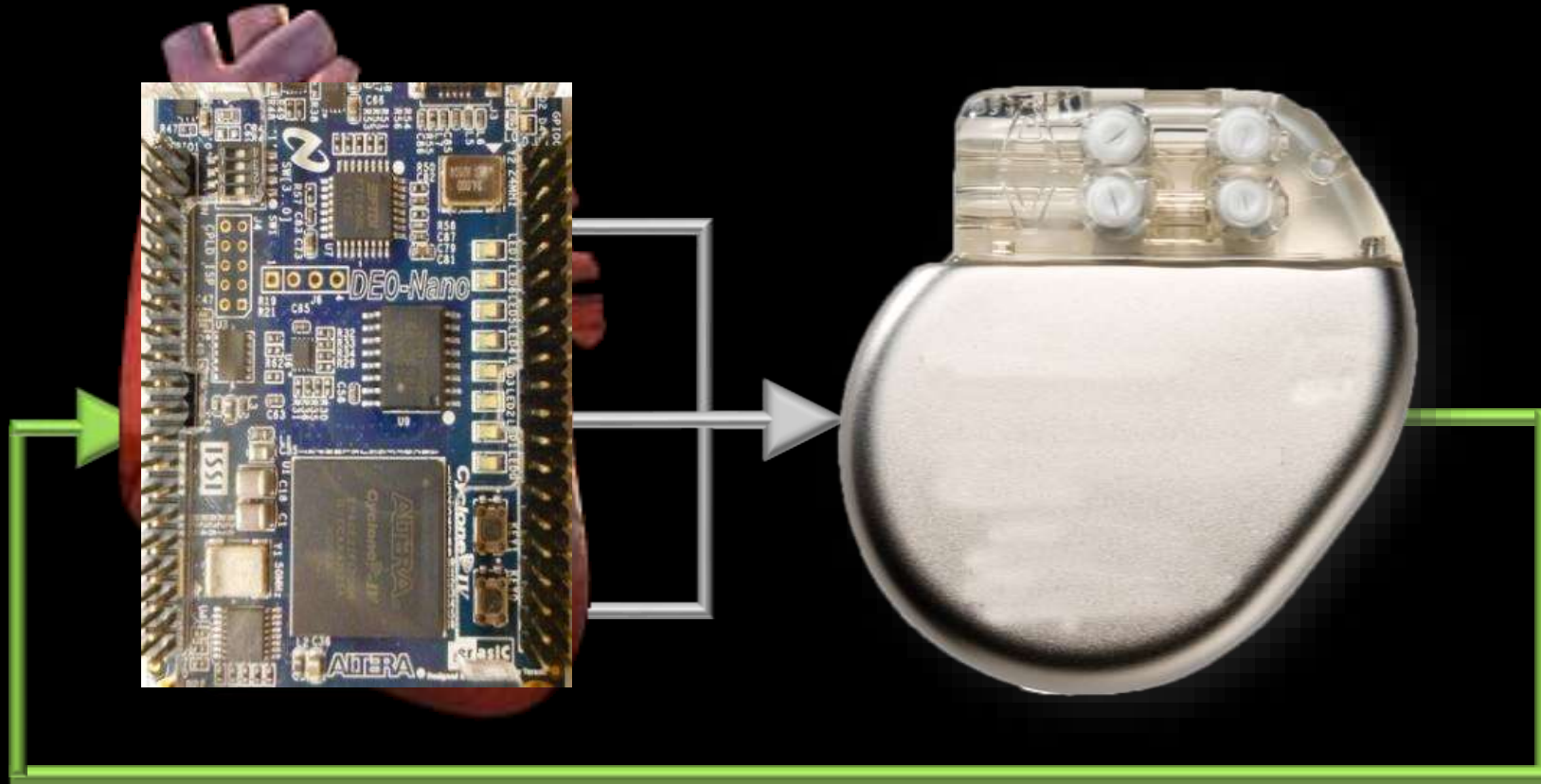

22 Aug 2019 | 12:00 GMT

Personalized Virtual Hearts Could Improve Cardiac Surgery

Digital replicas of patients' hearts can identify hidden, irregular heart tissue for surgeons to destroy

By **Megan Scudellari**

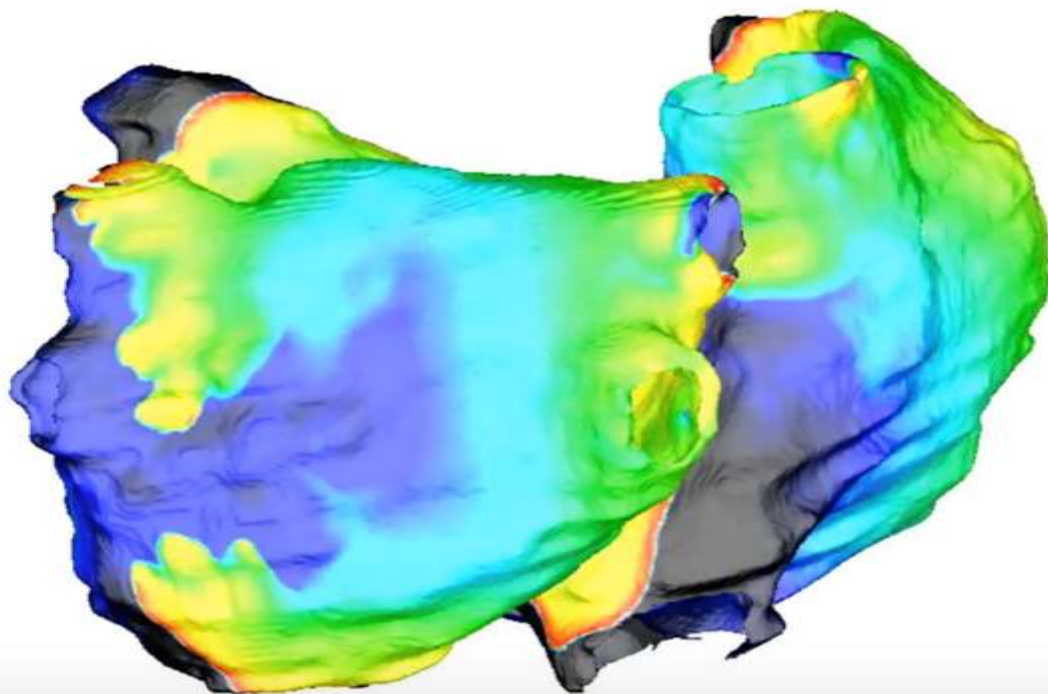

HEART MODELING

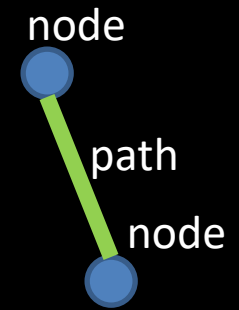
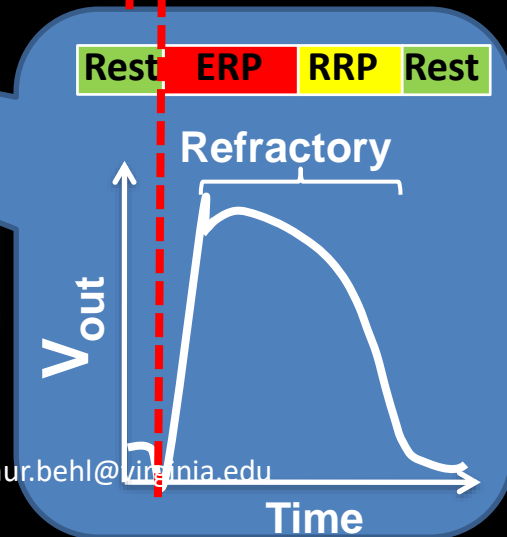
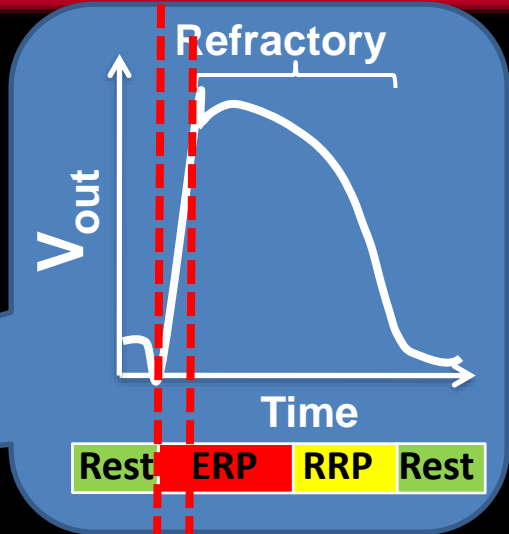
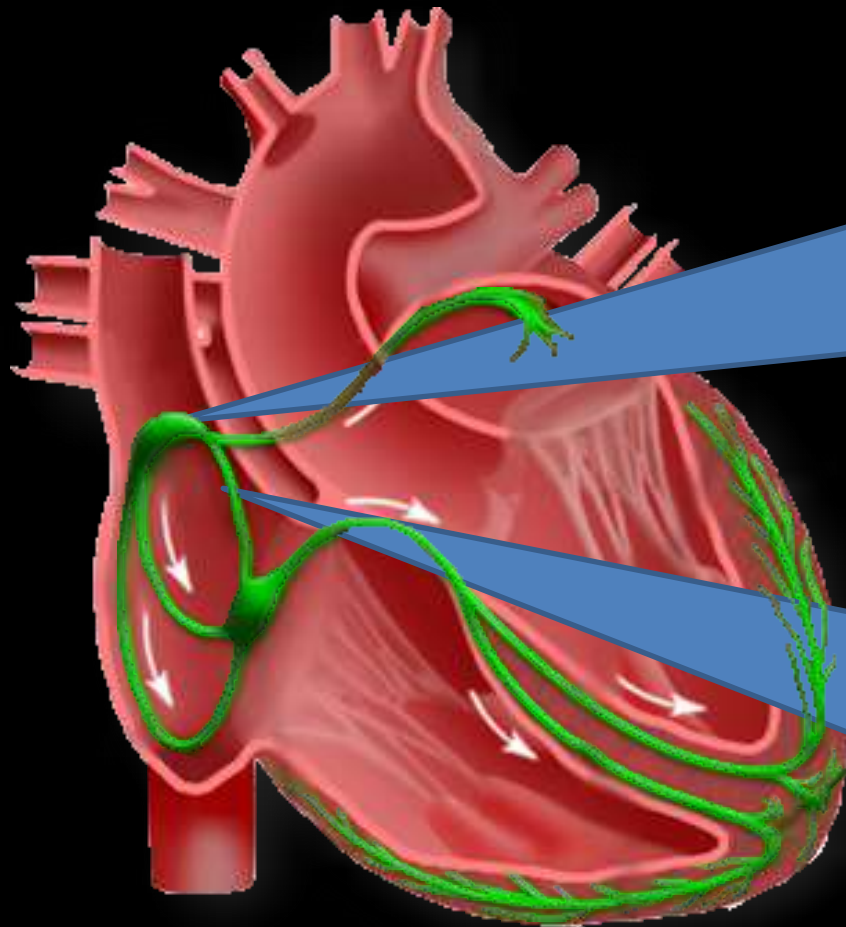

CLOSED-LOOP HEART MODELING

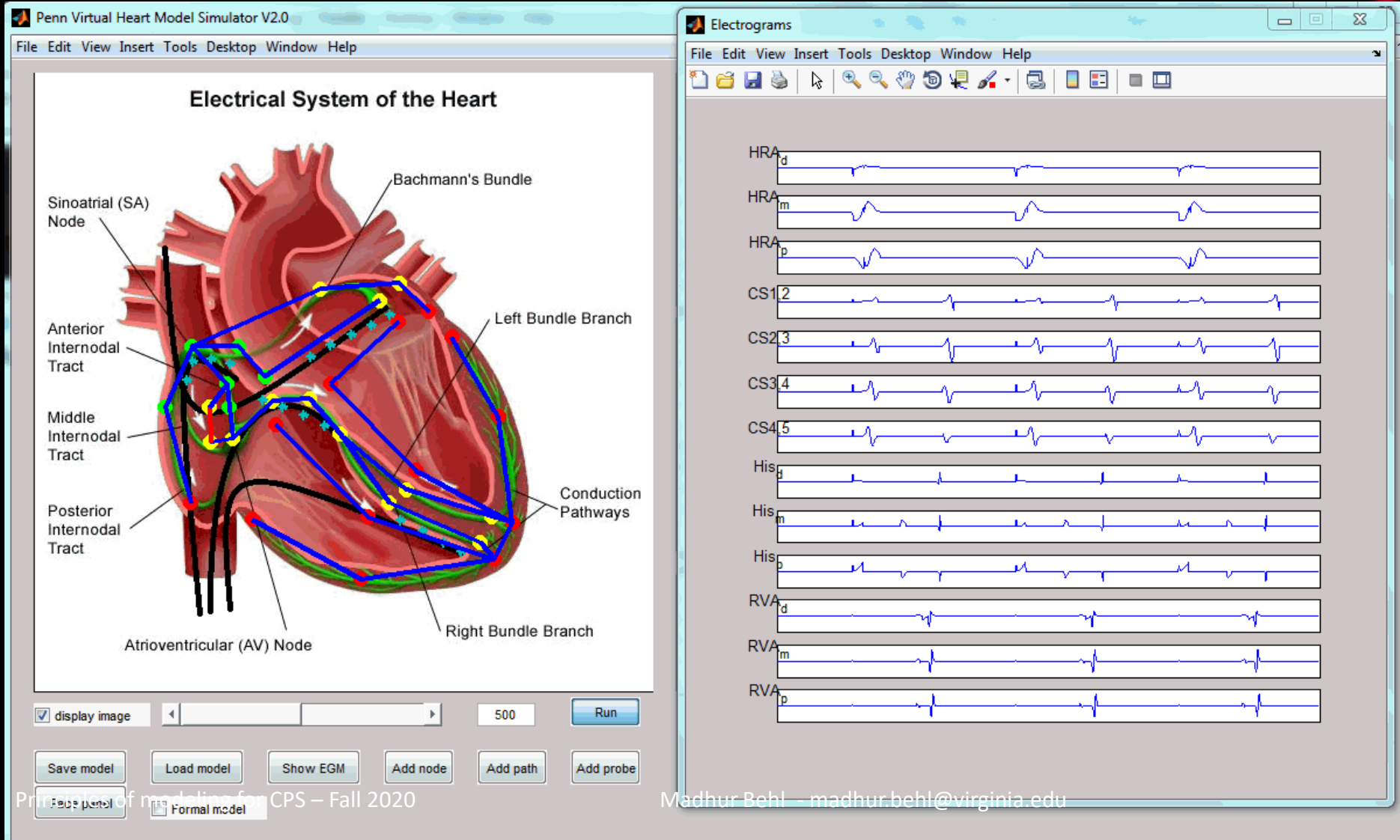

Node Automaton

- Divide refractory period into time periods
- Model refractory properties as timers using timed automata.
- These time periods can be measured during EP study

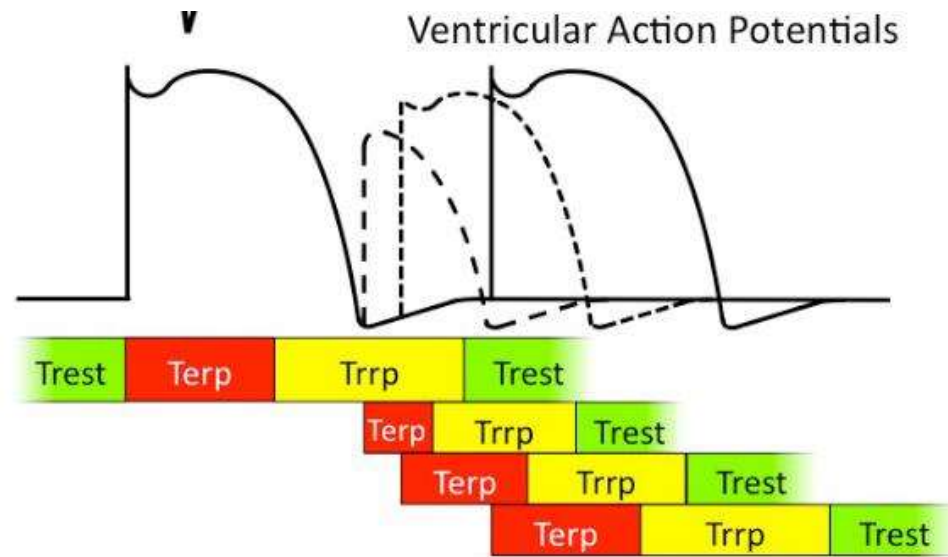

Node Automaton

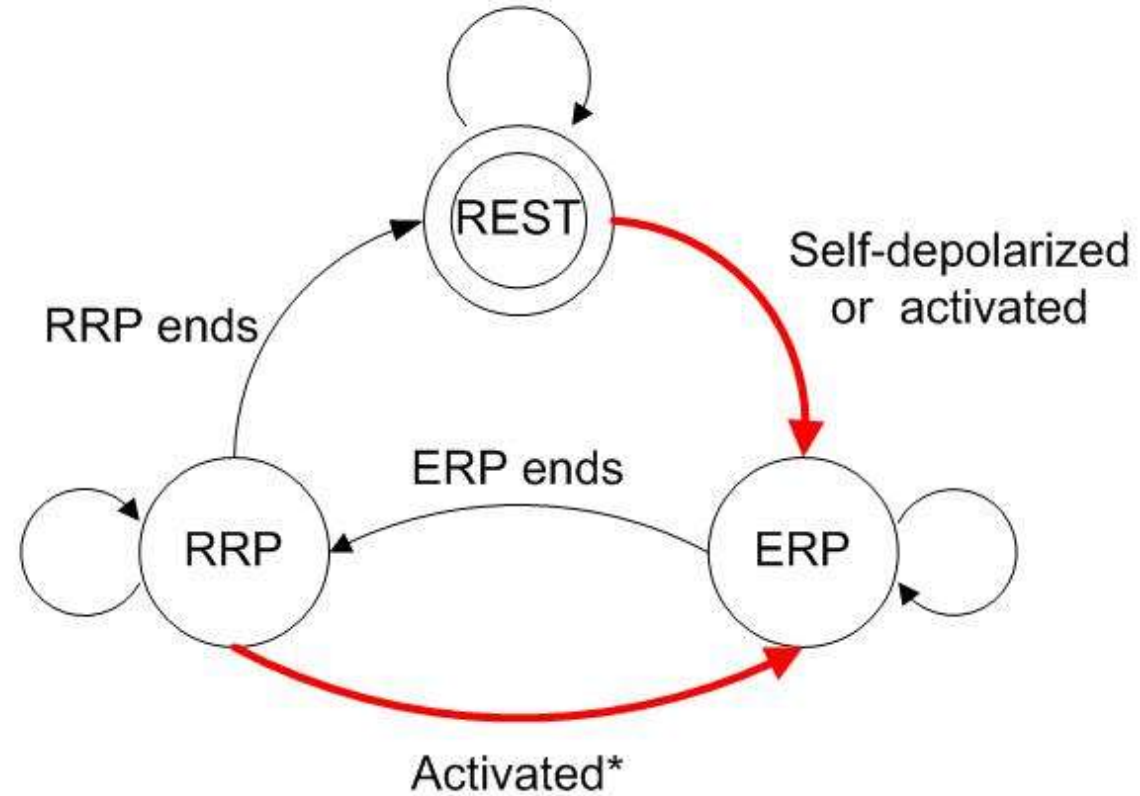

* With changes in ERP and conduction speed of paths connecting to the node

The UPPAAL model of the closed-loop system

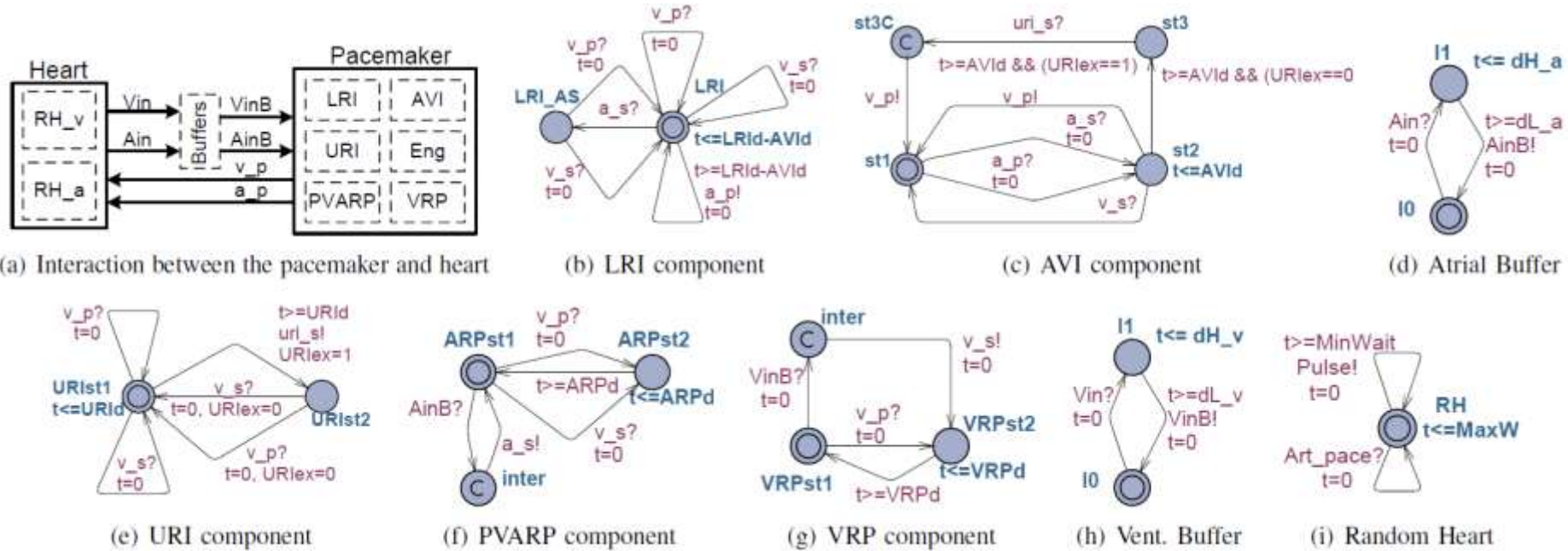

Model checking – Counter example guided.

Safety property

Ventricular rate should not be equal or above the upper rate limit for more than 30 beats

$A[] \text{not monitor.err}$

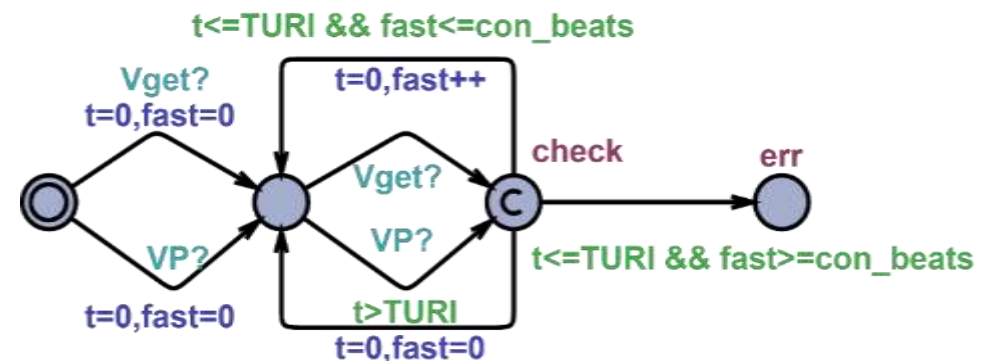
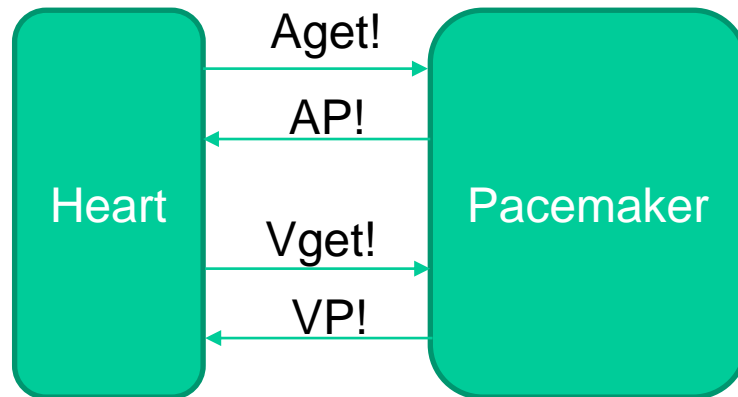

monitor

A blue wireframe model of a car, showing the chassis, wheels, and interior structure, set against a solid blue background.

Automotive CPS Module

Localization and Mapping

Where am I ?

Scene Understanding

Where/who/what/why of
everyone/everything else ?

Trajectory Planning and Control

Where should I go next ?
How do I steer and accelerate ?

Human Interaction

How do I convey my intent to the
passenger and everyone else ?

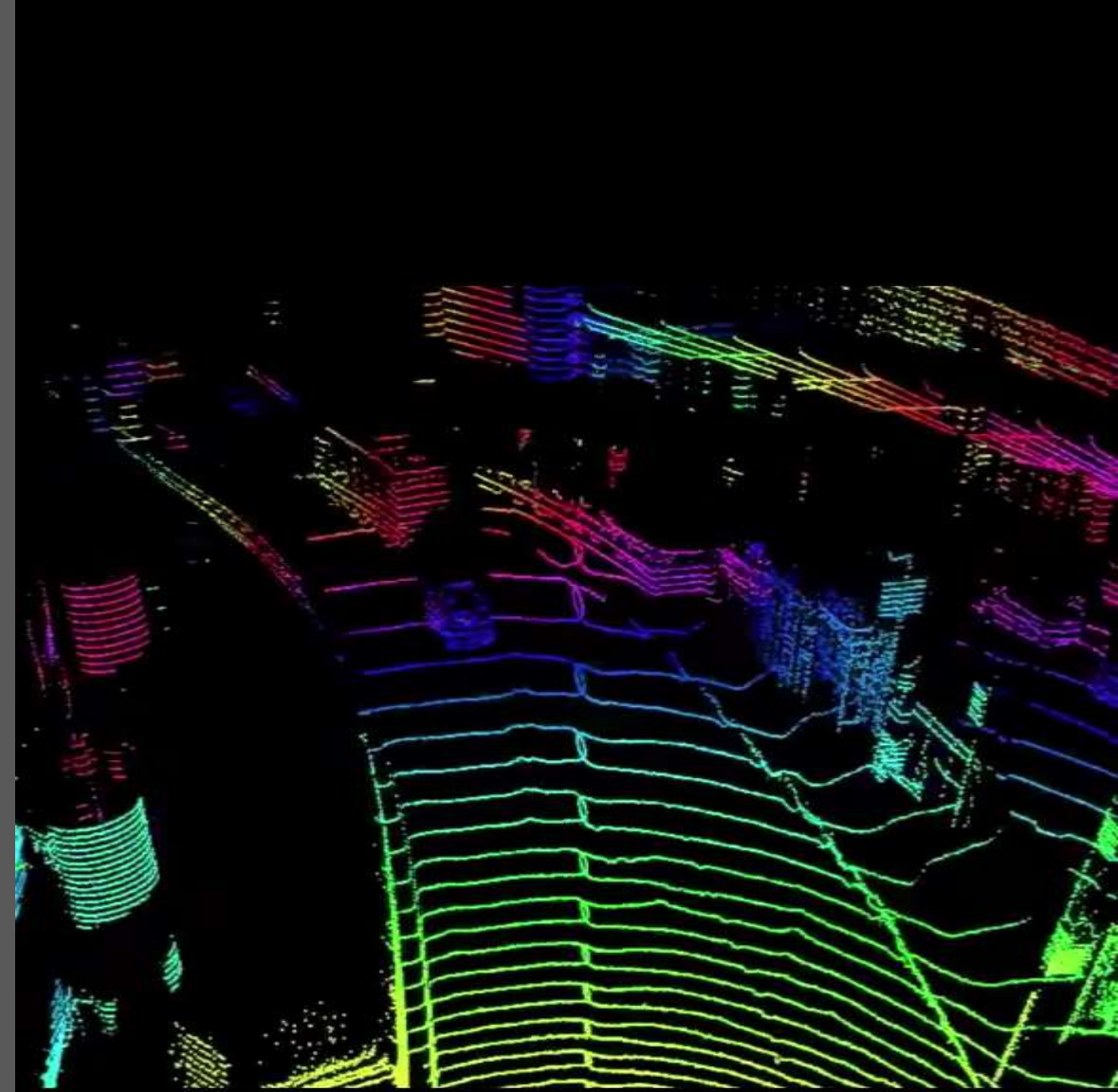

Localization and Mapping

Where am I ?

Scene Understanding

Where/who/what/why of
everyone/everything else ?

Deep Learning

Trajectory Planning and Control

Where should I go next ?
How do I steer and accelerate ?

Human Interaction

How do I convey my intent to the
passenger and everyone else ?

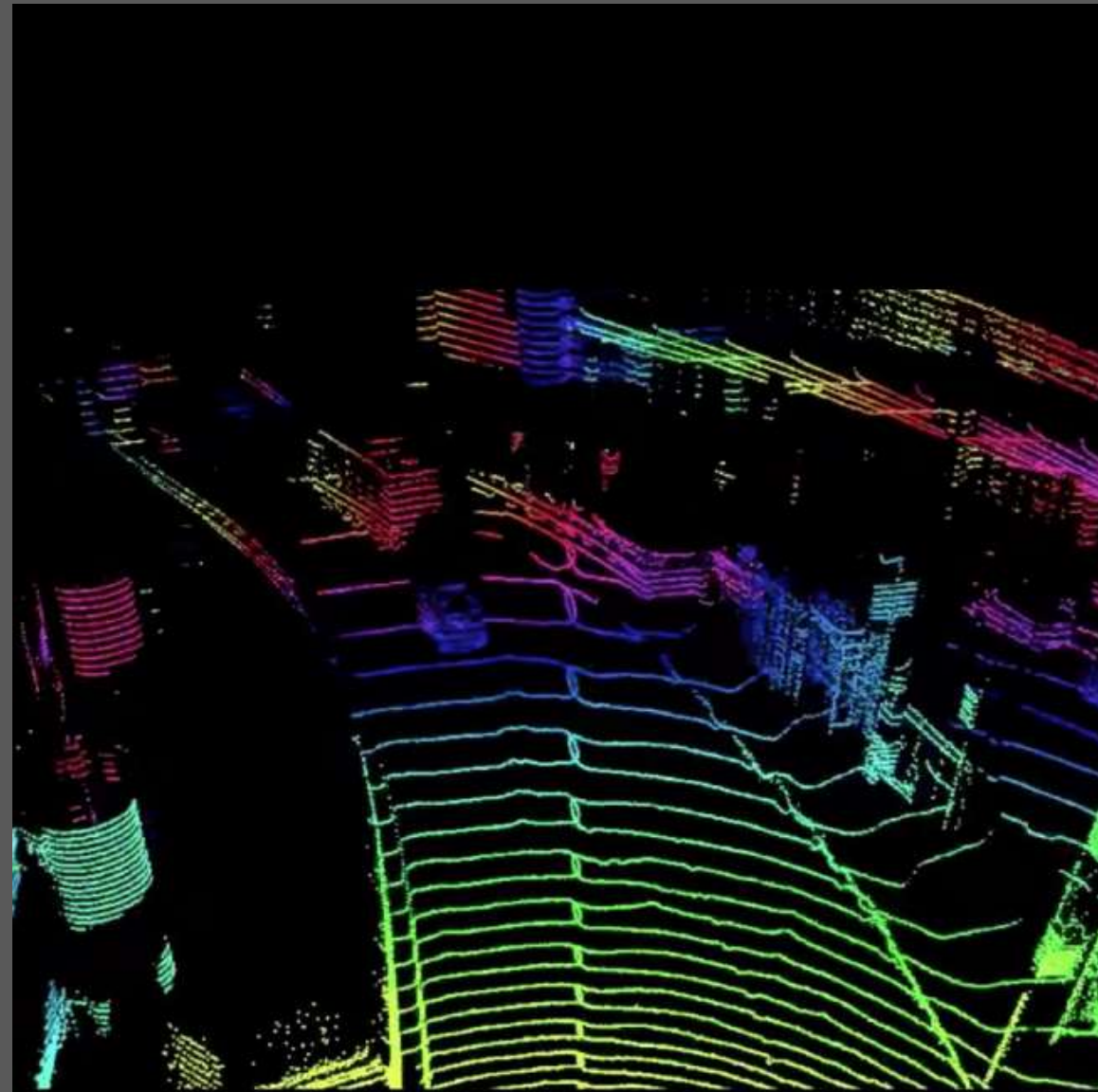

Localization and Mapping

Where am I ?

Scene Understanding

Where/who/what/why of everyone/everything else ?

Trajectory Planning and Control

Where should I go next ?
How do I steer and accelerate ?

Human Interaction

How do I convey my intent to the passenger and everyone else ?

Deep Neural Networks

End-to-end learnable

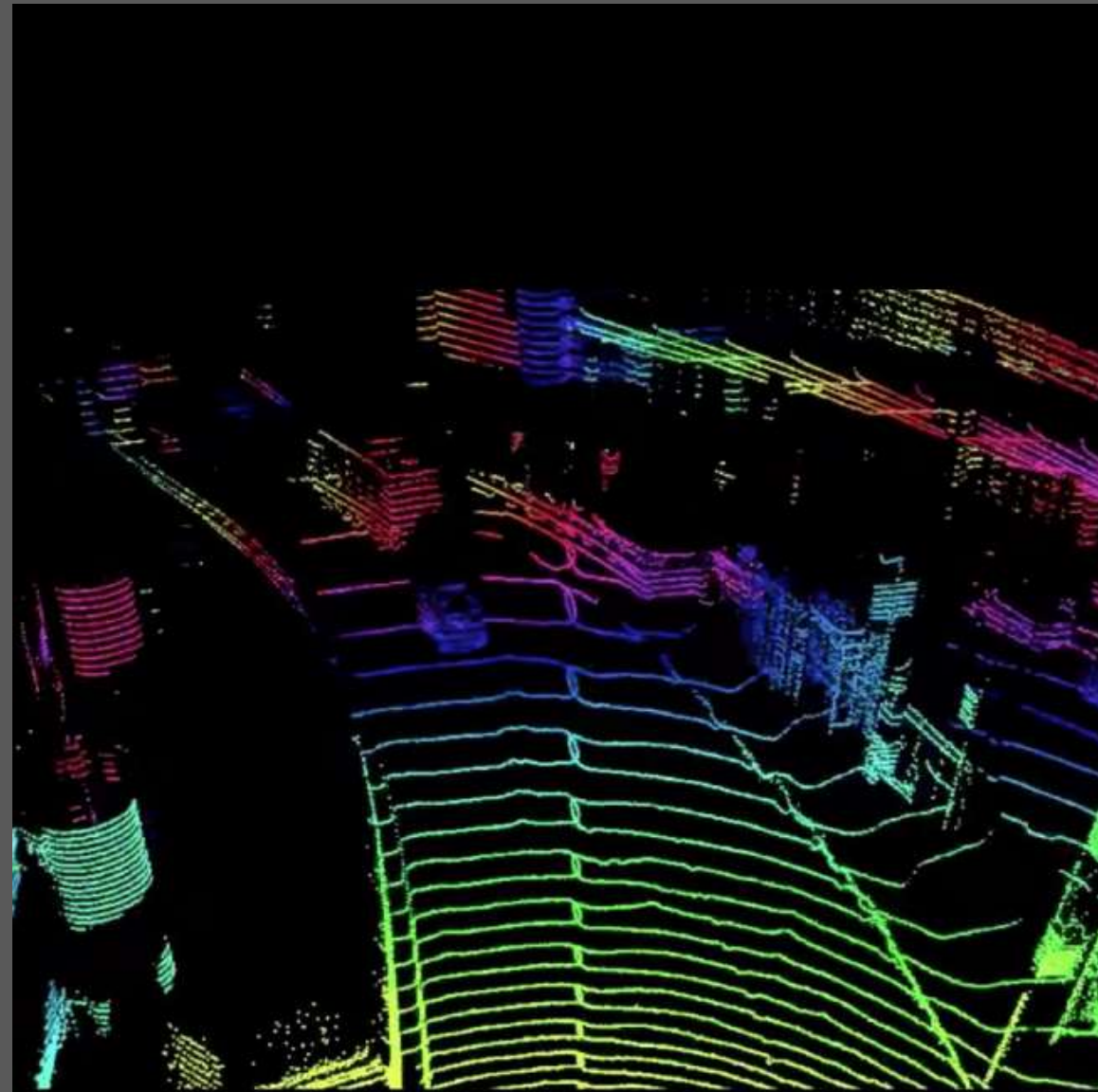

End-to-End Deep Learning for Self Driving Cars

- NVIDIA

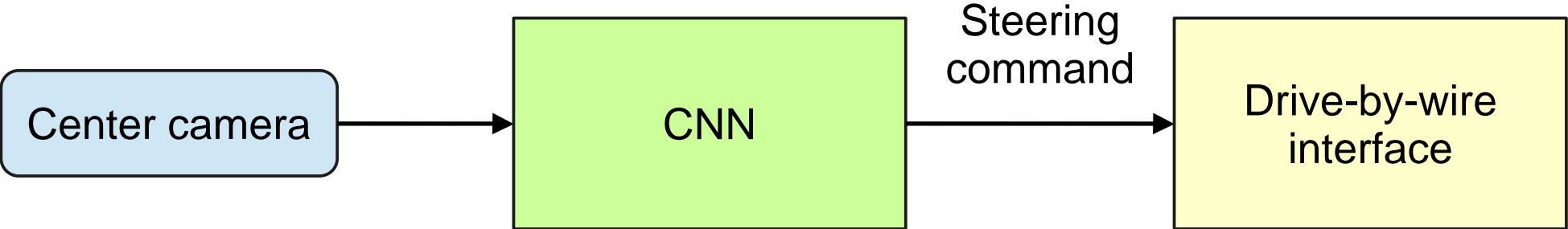

Video credit:
DeepTesla

Principles of modeling for CPS – Fall 2020

Madhur Behl - madhur.behl@virginia.edu

Machine intelligence is largely about training data.

When's a pedestrian not a pedestrian? When it's a decal.

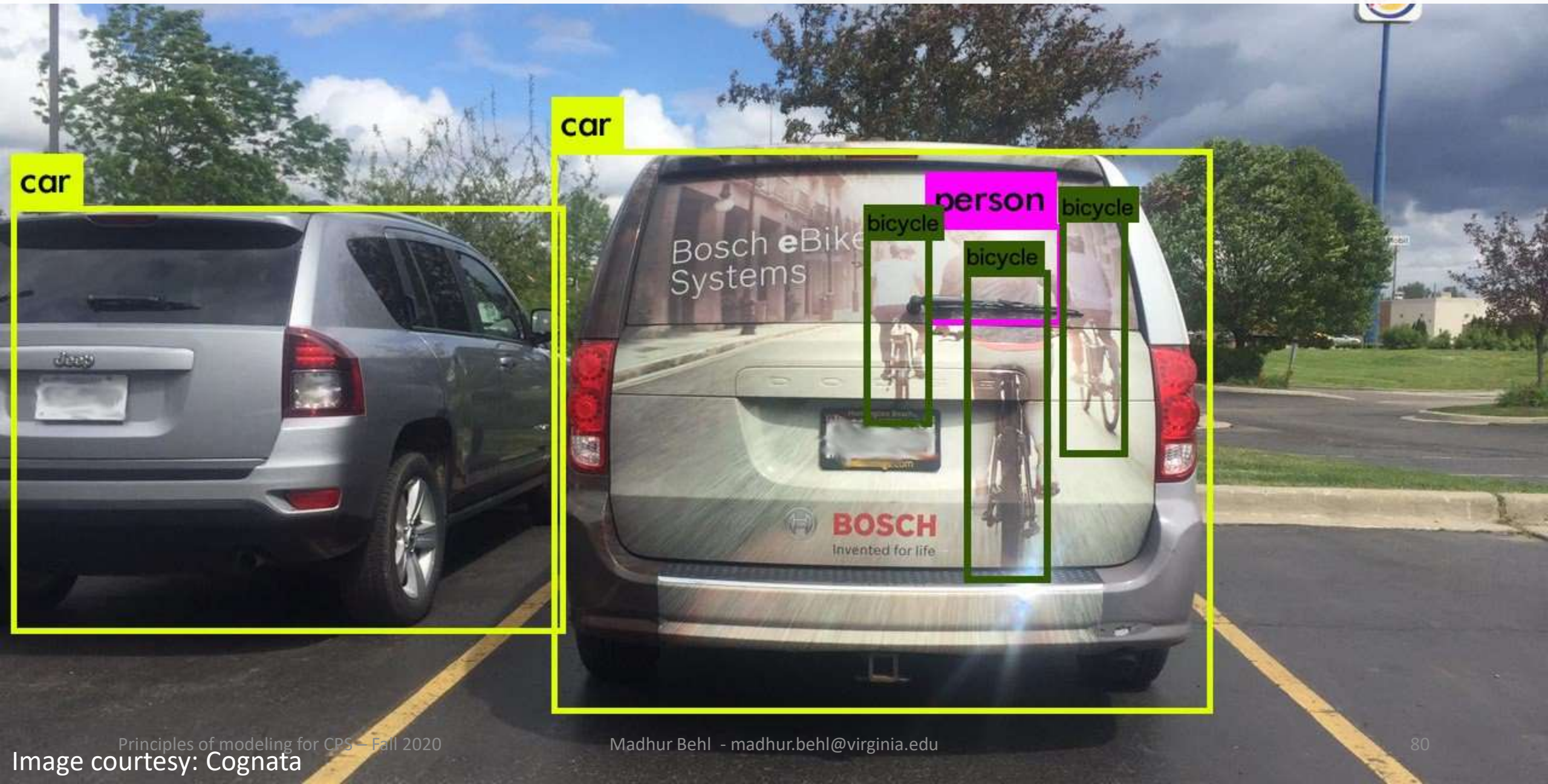

car

car

person

bicycle

bicycle

bicycle

One car ? or Multiple cars ?







Ramen Noodle place or Do Not Enter Sign ?



下鳥羽城/越町 付近
14:11:11 20m
現在地
AUDIO

今日 明日 16:10
現在地
気温(°C) 12/5 9/3
降水確率(%) 60 40
12°C A 77.5km 000160km

x1000 r/min
E D F
0 20 40 60 80 100 km/h





There is a bus right next to you!!

Autonomous Driving: End-to-End



Autonomous Driving: End-to-End

End to End Learning for Self-Driving Cars

Mariusz Bojarski
NVIDIA Corporation
Holmdel, NJ 07735

Davide Del Testa
NVIDIA Corporation
Holmdel, NJ 07735

Daniel Dworakowski
NVIDIA Corporation
Holmdel, NJ 07735

Bernhard Firner
NVIDIA Corporation
Holmdel, NJ 07735

Beat Flepp
NVIDIA Corporation
Holmdel, NJ 07735

Prasoon Goyal
NVIDIA Corporation
Holmdel, NJ 07735

Lawrence D. Jackel
NVIDIA Corporation
Holmdel, NJ 07735

Mathew Monfort
NVIDIA Corporation
Holmdel, NJ 07735

Urs Muller
NVIDIA Corporation
Holmdel, NJ 07735

Jiakai Zhang
NVIDIA Corporation
Holmdel, NJ 07735

Xin Zhang
NVIDIA Corporation
Holmdel, NJ 07735

Jake Zhao
NVIDIA Corporation
Holmdel, NJ 07735

Karol Zieba
NVIDIA Corporation
Holmdel, NJ 07735

Autonomous Driving: End-to-End

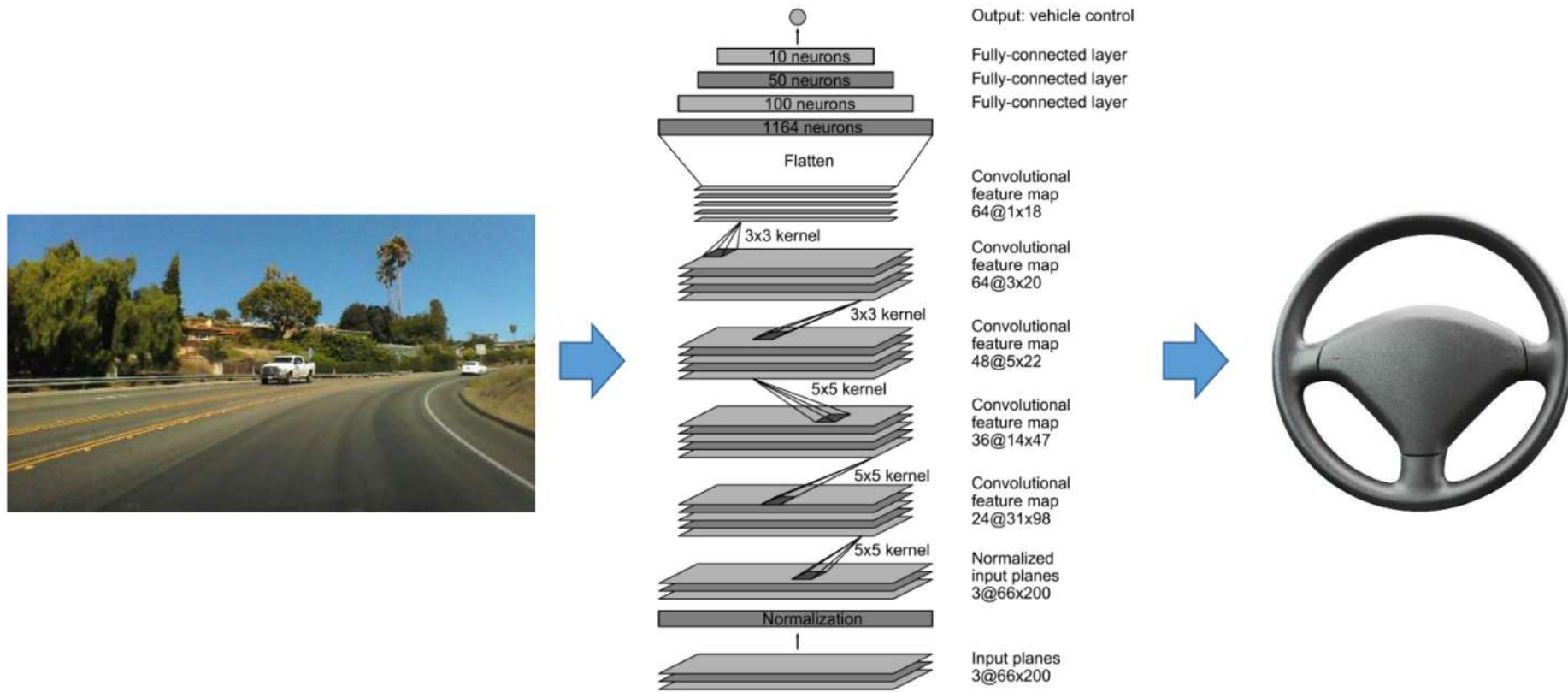



F1/10 FPV Driving





what is this course about ?

Principles of Modeling for Cyber-Physical Systems

Lets break it down..

1. What are Cyber-Physical Systems ?
2. What do you really mean by modeling ?
3. What principles am I going to learn about ?

This course: Modeling principles

- Modeling for predictive control.
- Parameter estimation.
 - Linear and non-linear
- Model checking
- Model validation
- Model selection
 - Model abstraction/reduced order modeling
- End-to-end learning

This course: Learning objectives

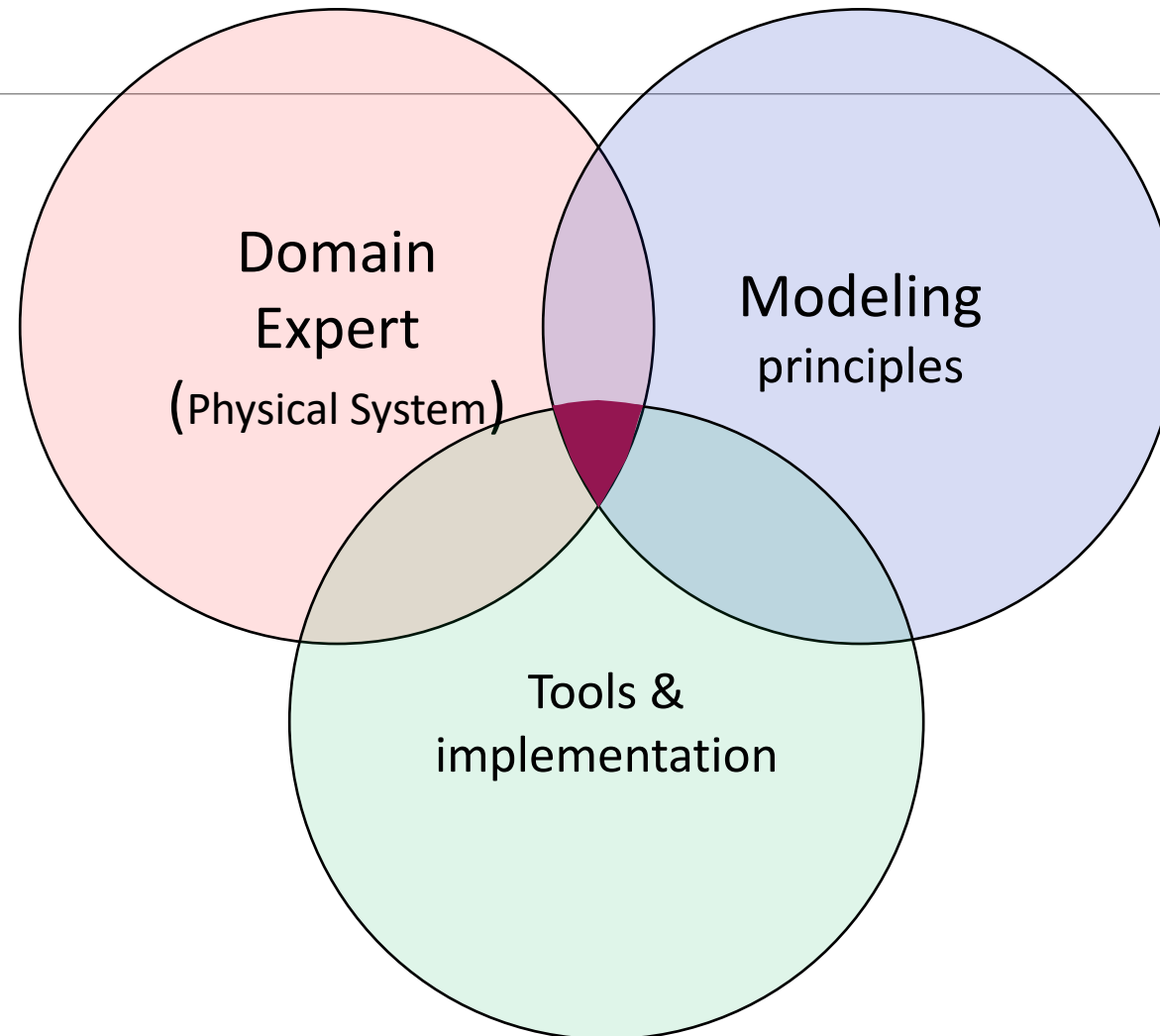

This course: Learning objectives

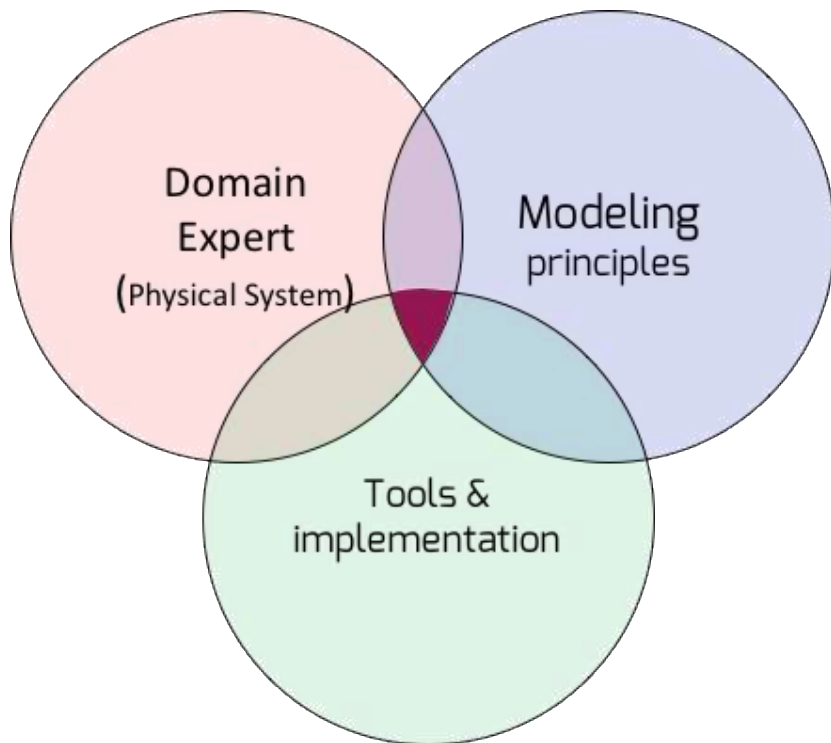

The future belongs to those who learn more skills and combine them in creative ways.

This course: Becoming a Cyber-Physicist

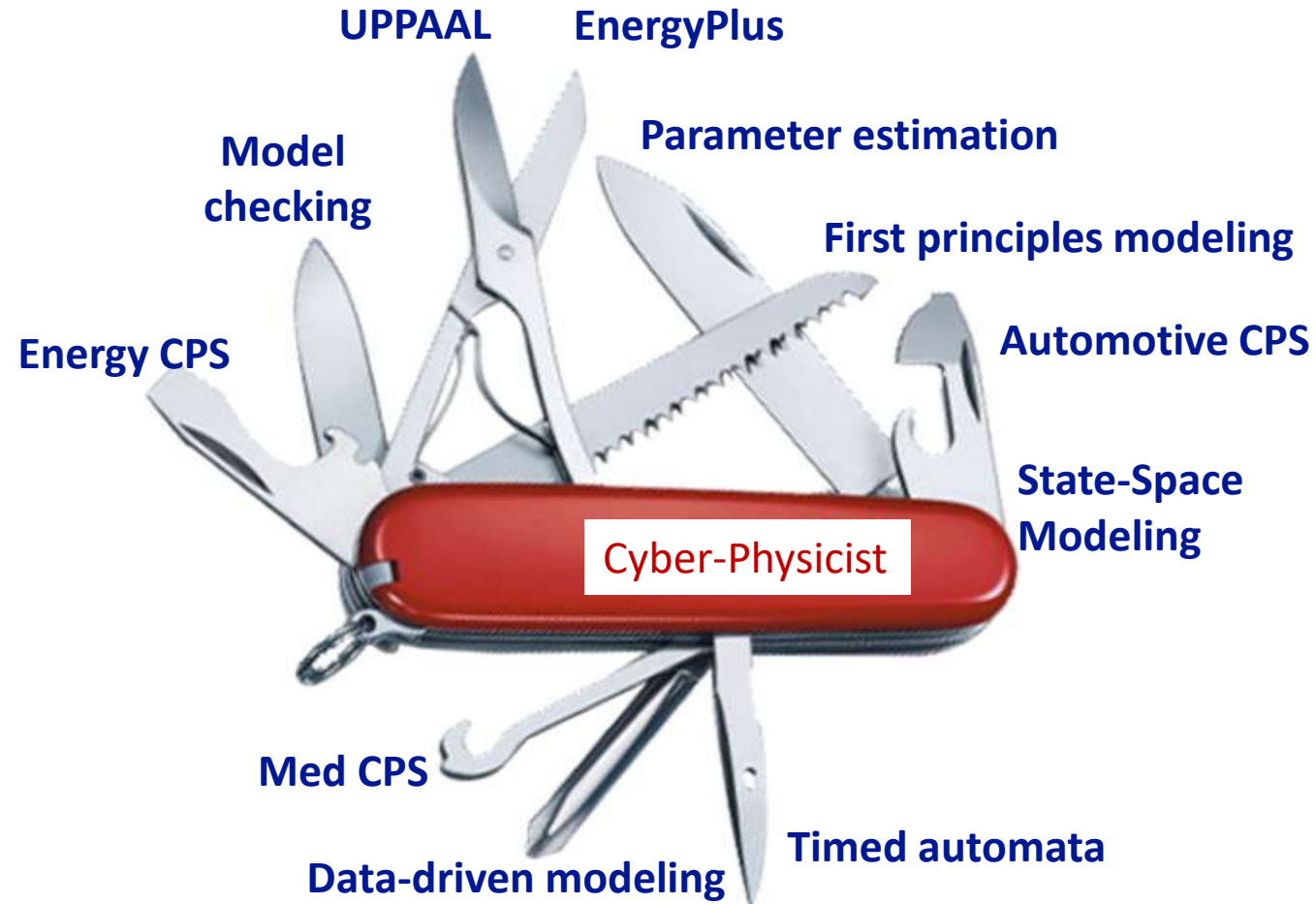

Next lecture:

- How to predict the future..
 - State-space modeling using first principles.
 - Mechanical, electrical, thermal systems
 - ODEs and elements of white box modeling